

OWNER'S MANUAL

SYLVANIA

ATSC/NTSC STB **6900DTD**



As an ENERGY STAR® Partner, our company has determined that this product meets the ENERGY STAR® guidelines for energy efficiency. ENERGY STAR® is a U.S. registered mark.

INSTRUCCIONES EN ESPAÑOL INCLUIDAS.

If you need additional assistance for set-up or operating after reading owner's manual, please call
TOLL FREE : 1-800-968-3429

Please read before using this equipment.

Table of Contents

1 Before Using	3
Important Safeguards	3
Precautions	5
Information on digital broadcasting	6
Major features of STB	7
Location of controls	8
Accessories	11
Installing batteries	11
Reference to SETUP menu	12
2 Connections.	16
Connections to antenna	16
Connections to other devices	18
3 Initial Setups (Setup Wizard)	25
Initial setup	25
4 Basic Operation	30
Watching TV	30
Channel banner	33
Choosing audio and language	35
Picture Still	37
On screen messages	38
5 Advanced Operation	39
Electronic Program Guide (EPG)	39
Setup menu for preference	42
CHANNEL	
Adding channels	43
Deleting channels	46
Adjusting antenna	49
Receiving channels	51
DISPLAY	
Selecting screen formats (Screen ratio and Display mode)	54
CLOCK	
Setting the clock	59
DETAIL	
Setting a new password	66
Setting for V-CHIP/CC	69
Setting MPAA rating	73
Setting TV rating	77
Selecting CC options	81
Choosing the screen language	84

6 Appendix	86
Troubleshooting	86
Specifications	88
Glossary and acronyms	88



Indice

7 Guía para rápida consulta (Español)	90
Ubicación de los controles	90
Instalación de las pilas	91
Conexiones de antena	92
Conexión del STB a un SDTV utilizando la salida VIDEO	93
Configuración inicial	94

Warranty Back Cover

WARNING: TO REDUCE THE RISK OF FIRE OR ELECTRIC SHOCK, DO NOT EXPOSE THIS APPLIANCE TO RAIN OR MOISTURE.

	CAUTION RISK OF ELECTRIC SHOCK DO NOT OPEN	
<p>CAUTION: TO REDUCE THE RISK OF ELECTRIC SHOCK, DO NOT REMOVE COVER (OR BACK). NO USER SERVICEABLE PARTS INSIDE. REFER SERVICING TO QUALIFIED SERVICE PERSONNEL.</p>		

	<p>THIS SYMBOL INDICATES THAT DANGEROUS VOLTAGE CONSTITUTING A RISK OF ELECTRIC SHOCK IS PRESENT WITHIN THIS UNIT.</p>
	<p>THIS SYMBOL INDICATES THAT THERE ARE IMPORTANT OPERATING AND MAINTENANCE INSTRUCTIONS IN THE LITERATURE ACCOMPANYING THE APPLIANCE.</p>

The caution marking is located on the rear of the cabinet.

IMPORTANT SAFEGUARDS

- 1. Read instructions-**All the safety and operating instructions should be read before the appliance is operated.
- 2. Retain Instructions-**The safety and operating instructions should be retained for future reference.
- 3. Heed Warnings-**All warnings on the appliance and in the operating instructions should be adhered to.
- 4. Follow Instructions-**All operating and use instructions should be followed.
- 5. Cleaning-**Unplug this product from the wall outlet before cleaning. Do not use liquid cleaners or aerosol cleaners. Use a damp cloth for cleaning.
EXCEPTION: A product that is meant for uninterrupted service and, that for some specific reason, such as the possibility of the loss of an authorization code for a CATV converter, is not intended to be unplugged by the user for cleaning or any other purpose, may exclude the reference to unplugging the appliance in the cleaning description otherwise required in item 5.
- 6. Attachments-**Do not use attachments not recommended by this product manufacturer as they may cause hazards.
- 7. Water and Moisture-**Do not use this product near water-for example, near a bath tub, wash bowl, kitchen sink, or laundry tub, in a wet basement, or near a swimming pool, and the like.
- 8. Accessories-**Do not place this product on an unstable cart, stand, tripod, bracket, or table. This product may fall, causing serious injury to someone, and serious damage to the appliance. Use only with a cart, stand, tripod, bracket, or table recommended by the manufacturer, or sold with this product. Any mounting of the appliance should follow the manufacturer's instructions and should use a mounting accessory recommended by the manufacturer. An appliance and cart combination should be moved with care. Quick stops, excessive force, and uneven surfaces may cause the appliance and cart combination to overturn.



AMEUBLES- Cet appareil ne doit être placé que sur un meuble (avec ou sans roulettes) recommandé par le fabricant. Si vous l'installez sur un meuble à roulettes, déplacez les deux ensembles avec précaution. Un arrêt brusque, l'utilisation d'une force excessive et des surfaces irrégulières risquent de déstabiliser l'ensemble et de le renverser.



- 9. Ventilation-**Slots and openings in the cabinet and the back or bottom are provided for ventilation and to ensure reliable operation of this product and to protect it from overheating, and these openings must not be blocked or covered. The openings should never be blocked by placing this product on a bed, sofa, rug, or other similar surface. This product should never be placed near or over a radiator or heat register. This product should not be placed in a built-in installation such as a bookcase or rack unless proper ventilation is provided or the manufacturer's instructions have been adhered to.
- 10. Power Sources-**This product should be operated only from the type of power source indicated on the marking label. If you are not sure of the type of power supply to your home, consult your appliance dealer or local power company. For this products intended to operate from battery power, or other sources, refer to the operating instructions.
- 11. Grounding or Polarization-**This product is equipped with a polarized alternating-current line plug(a plug having one blade wider than the other). This plug will fit into the power outlet only one way. This is a safety feature. If you are unable to insert the plug fully into the outlet, try reversing the plug. If the plug should still fail to fit, contact your electrician to replace your obsolete outlet. Do not defeat the safety purpose of the polarized plug.
- 12. Power-Cord Protection-**Power-supply cords should be routed so that they are not likely to be walked on or pinched by items placed upon or against them, paying particular attention to cords at plugs, convenience receptacles, and the point where they exit from the appliance.

FIGURE A
EXAMPLE OF ANTENNA GROUNDING AS PER
NATIONAL ELECTRICAL CODE

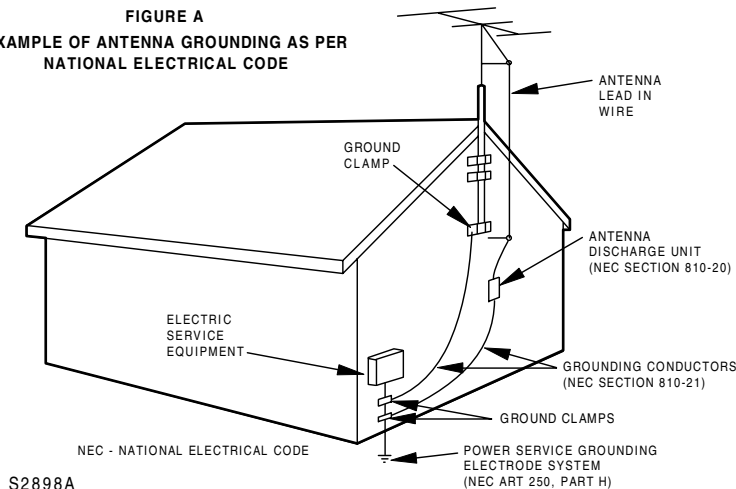

13. Outdoor Antenna grounding-If an outside antenna or cable system is connected to this product, be sure the antenna or cable system is grounded so as to provide some protection against voltage surges and built-up static charges. Article 810 of the National Electrical Code, ANSI/NFPA No. 70, provides information with respect to proper grounding of the mast and supporting structure, grounding of the lead-in wire to an antenna discharge unit, size of grounding conductors, location of antenna-discharge unit, connection to grounding electrodes, and requirements for the grounding electrode. (Fig. A)

14. Lightning-For added protection for this product receiver during a lightning storm, or when it is left unattended and unused for long periods of time, unplug it from the wall outlet and disconnect the antenna or cable system. This will prevent damage to this product due to lightning and power-line surges.

15. Power Lines-An outside antenna system should not be located in the vicinity of overhead power lines or other electric light or power circuits, or where it can fall into such power lines or circuits. When installing an outside antenna system, extreme care should be taken to keep from touching such power lines or circuits as contact with them might be fatal.

16. Overloading-Do not overload wall outlets and extension cords as this can result in a risk of fire or electric shock.

17. Object and Liquid Entry-Never push objects of any kind into this product through openings as they may touch dangerous voltage points or short out parts that could result in a fire or electric shock. Never spill liquid of any kind on this product.

18. Servicing-Do not attempt to service this product yourself as opening or removing covers may expose you to dangerous voltage or other hazards. Refer all servicing to qualified service personnel.

19. Damage Requiring Service-Unplug this product from the wall outlet and refer servicing to qualified service personnel under the following conditions:

- When the power-supply cord or plug is damaged or frayed.
- If liquid has been spilled, or objects have fallen into this product.
- If this product has been exposed to rain or water.
- If this product does not operate normally by following the operating instructions. Adjust only those controls that are covered by the operating instructions, as improper adjustment of other controls may result in damage and will often require extensive work by a qualified technician to restore this product to its normal operation.
- If this product has been dropped or damaged in any way.
- When this product exhibits a distinct change in performance-this indicates a need for service.

20. Replacement Parts-When replacement parts are required, be sure the service technician has used replacement parts specified by the manufacturer that have the same characteristics as the original part. Unauthorized substitutions may result in fire, electric shock, injury to persons or other hazards.

21. Safety Check-Upon completion of any service or repairs to this product, ask the service technician to perform routine safety checks to determine that this product is in proper operating condition.

22. Heat-This product should be situated away from heat sources such as radiators, heat registers, stoves, or other products (including amplifiers) that produce heat.

CAUTION: TO PREVENT ELECTRIC SHOCK, MATCH WIDE BLADE OF PLUG TO WIDE SLOT, FULLY INSERT.

ATTENTION: POUR ÉVITER LES CHOC ÉLECTRIQUES, INTRODUIRE LA LAME LA PLUS LARGE DE LA FICHE DANS LA BORNE CORRESPONDANTE DE LA PRISE ET POUSSER JUSQU'AU FOND.

PRECAUTIONS

LOCATION

For safe operation and satisfactory performance of your this product, keep the following in mind when selecting a place for its installation:

- Shield it from direct sunlight and keep it away from sources of intense heat.
- Avoid dusty or humid places.
- Avoid places with insufficient ventilation for proper heat dissipation. Do not block the ventilation holes at the top and bottom of the unit. Do not place the unit on a carpet because this will block the ventilation holes.
- Install unit in a horizontal position.
- Avoid locations subject to strong vibration.
- Do not place this product near strong magnetic fields.
- Avoid moving this product to locations where temperature differences are extreme.

AVOID THE HAZARDS OF ELECTRICAL SHOCK AND FIRE

- Do not handle the power cord with wet hands.
- Do not pull on the power cord when disconnecting it from an AC wall outlet. Grasp it by the plug.
- If, by accident, water is spilled on your unit, unplug the power cord immediately and take the unit to our Authorized Service Center for servicing.
- Do not put your fingers or objects into this product cassette holder.
- Do not place anything directly on top of the unit.

IMPORTANT COPYRIGHT INFORMATION

Unauthorized recording or use of broadcast television programming, video tape, film or other copyrighted material may violate applicable copyright laws. We assume no responsibility for the unauthorized duplication, use, or other acts which infringe upon the rights of copyright owners.

FCC WARNING- This equipment may generate or use radio frequency energy. Changes or modifications to this equipment may cause harmful interference unless the modifications are expressly approved in the instruction manual. The user could lose the authority to operate this equipment if an unauthorized change or modification is made.

This equipment has been tested and found to comply with the limits for a Class B digital device, pursuant to Part 15 of the FCC Rules. These limits are designed to provide reasonable protection against harmful interference in a residential installation. This equipment generates, uses, and can radiate radio frequency energy and, if not installed and used in accordance with the instructions, may cause harmful interference to radio communications. However, there is no guarantee that interference will not occur in a particular installation. If this equipment does cause harmful interference to radio or television reception, which can be determined by turning the equipment off and on, the user is encouraged to try to correct the interference by one or more of the following measures:

- 1) Reorient or relocate the receiving antenna.
- 2) Increase the separation between the equipment and receiver.
- 3) Connect the equipment into an outlet on a circuit different from that to which the receiver is connected.
- 4) Consult the dealer or an experienced radio/TV technician for help.

The serial number of this product may be found on the back of the unit. No others has the same serial number as yours. You should record the number and other vital information here and retain this book as a permanent record of your purchase to aid identification in case of theft. Serial numbers are not kept on file.

Date of Purchase	
Dealer Purchase from	
Dealer Address	
Dealer Phone No.	
Model No.	
Serial No.	

Information on digital broadcasting

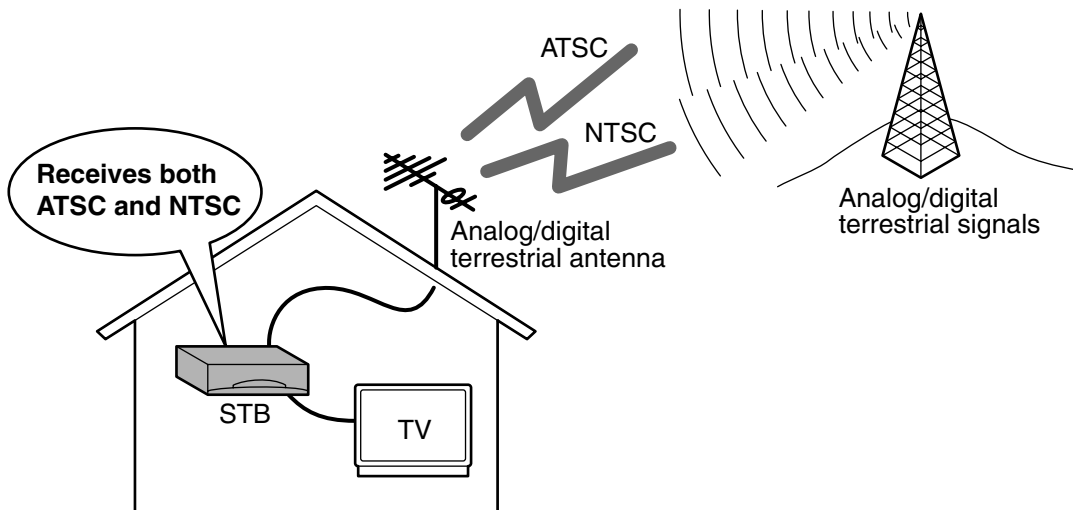

Digital broadcasting is the most advanced format of broadcasting, employing a new technology for compression of audio and video signals which allows broadcasters to transmit digital signals using existing terrestrial systems.

Due to this dramatic progress, new features of broadcasting service such as widescreen formats and higher definition can provide a way to experience the full benefits of digital transmission.

High Definition Television (HDTV*) broadcasts can provide pictures twice as sharp as a conventional broadcast and features sound encoded with Dolby® digital* 5.1 surround sound. When connected to a receiver (sold separately) that features Dolby® digital decoding will provide a true theater experience in the home.

Digital broadcasting has overcome problems experienced with analog television such as ghosting, "snowy" pictures and interference. Digital television has a dramatic effect on these problems by its very nature. In addition, the number of channels available has dramatically increased, so that you can make the best choice among the variety of programs anytime with a clear picture.

The benefits extend not only to HDTV. It will also be possible to transmit multiple Standard Definition Television (SDTV*) programs within the same bandwidth. Some data capacity could also be allocated to provide more effective closed captioning or multiple language soundtracks.

Your current TV should be used for its entire service life.
STB will make this possible.

Major features of STB

- Capable of receiving digital (ATSC*), analog (NTSC*), and cable (NTSC) broadcasts
- Capable of receiving High Definition TV broadcasts
- Capable of receiving Dolby® digital 5.1 audio
- Alternate languages for OSD are available. (English, Spanish, French)
- Component video output jacks (Y/ Pb/ Pr)
- Sub-channels* are available through a single digital channel.

HDTV:

High Definition Television:

HDTV signal formats are 1080i (interlaced scan) and 720p (progressive scan). HDTV provides the highest resolution picture and audio in either stereo or 5.1 channel surround sound.

Dolby® Digital:

Dolby® Digital (when available) provides 6 independent soundtrack channels through the coaxial output jack.

STB has a Dolby Digital output (labeled DIGITAL AUDIO (COAXIAL)) that can be connected to an external Digital Audio receiver/ decoder equipped with a coaxial input. With additional equipment you can enjoy more dynamic and realistic sound at home.

SDTV:

Standard Definition Television:

SDTV signal formats are 480p and 480i. SDTV provides lower resolution, yet presents a very sharp, clear picture. Lower resolution allows broadcasters to transmit multiple programs per channel.

ATSC:

ATSC (Advanced Television Systems Committee) is the group that has been working to establish the standards for digital television broadcasting and digital television equipment - including both SDTV and HDTV.

NTSC:

NTSC (National Television Standards Committee) refers to the group that first established the standards used for conventional analog television broadcasting and TV equipment.

Sub-Channel:

Because of the compression of audio and video signals, each digital channel is able to carry different programs on sub-channels through a single channel. You can select them by simply pressing CH ▲ / ▼ buttons on your remote control when available.

Location of controls

FRONT PANEL

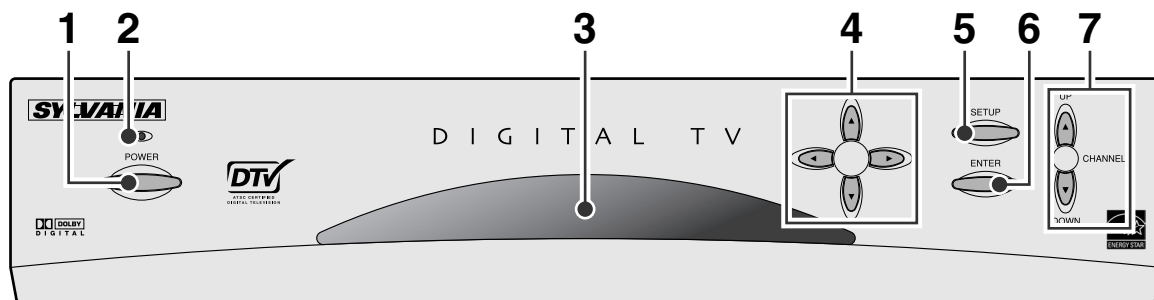

1 POWER button:

Turns STB on and off.

2 POWER indicator:

Lights up while STB is on.

NOTE:

When turning the STB on, the power indicator will blink first and light up.

When turning the STB off, the power indicator will blink first and go off.

3 Remote control sensor:

Receives signals from your remote control and enables you to control STB from a distance.

4 Navigation buttons ▲ / ▼ / ◀ / ▶:

Press to move the selected item or menu up, down, left or right.

5 SETUP button:

Press to enter or exit SETUP menu.

6 ENTER button:

In SETUP menu, press to determine your selection.

7 CHANNEL ▲ / ▼ buttons:

Press to change the channels up or down.

REAR PANEL

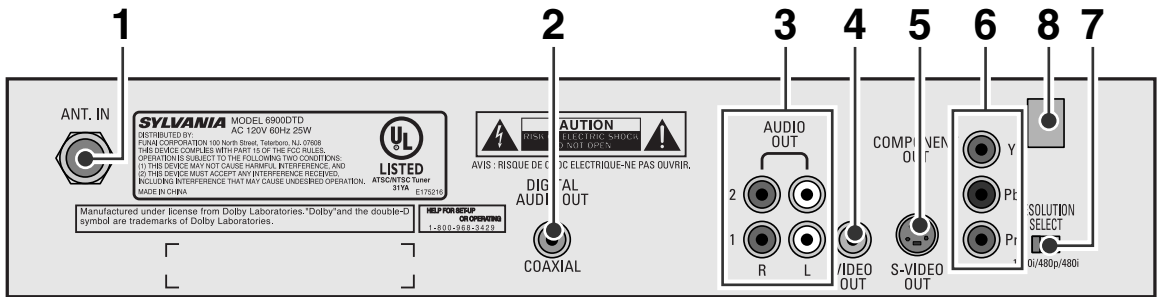

1 ANT. IN Jack:

Use to connect an antenna to STB.

2 DIGITAL AUDIO (COAXIAL) Jack:

Use to connect a decoder or an amplifier to STB with a digital coaxial cable.

NOTE:

You must use this jack and a Dolby® Digital receiver for Dolby® Digital 5.1 playback.

3 AUDIO R/ L Jacks: (2 pairs)

Use to connect your TV, a stereo system or a VCR to STB with standard audio cables.

NOTE for audio output:

There will be both digital audio output and analog audio output during digital broadcast. There will be only analog audio output during analog broadcast. When you want digital audio output during digital broadcast, the digital audio (coaxial) jack must be used.

Refer to the page describing the connection to a decoder with Dolby® Digital.

4 VIDEO Jack: (Composite)

Use to connect your TV or a VCR to STB with a standard video cable.

5 S-VIDEO Jack:

Use to connect your TV to STB with an S-Video cable.

NOTE:

When you use an S-Video cable, a composite video cable (yellow) is not necessary.

6 COMPONENT VIDEO JACKS (Y/ Pb/ Pr):

Use to connect your TV to STB with component video cables.

NOTE:

This connection is required to display a high definition broadcast.

Y (green), Pb (blue), Pr (red)

7 Resolution selection switch (1080i/ 480p/ 480i):

Use to select the STB video output resolution 1080i, 480p and 480i. The default setting is 480i.

8 AC power cord:

Connect to AC outlet.

REMOTE CONTROL

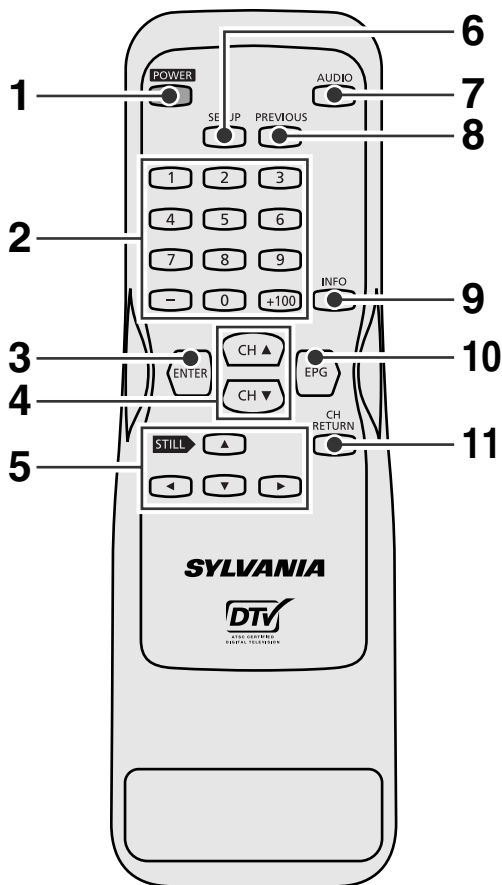

- 1 POWER button:**
Turns STB on and off.
- 2 Number buttons:**
Use to input channel numbers and passwords, and to set time.
- 3 ENTER button:**
In SETUP menu, press to determine your selection.
- 4 CH ▲ / ▼ buttons:**
Press to change the channels up or down.
- 5 Navigation buttons ▲ / ▼ / ◀ / ▶:**
Press to move the highlight up, down, left or right.
The video pauses by pressing STILL ▲ button while you can listen to the program audio.
- 6 SETUP button:**
Press to enter or quit SETUP menu.
- 7 AUDIO button:**
Use to select an alternate audio track while watching a TV program.
- 8 PREVIOUS button:**
Use to go back to the previous screen in SETUP menu or to exit.
- 9 INFO button:**
Use to display further information on the channel banner or to exit.
- 10 EPG button:**
Use to display EPG (Electronic Program Guide) or to exit.
- 11 CH RETURN button:**
Use to return to the channel you were last watching.

Accessories

You will find STB and the following accessories when unpacking the carton box of STB:

STB
6900DTD



Remote controller unit and AA batteries (x2)
(PART No.: NE120UD)

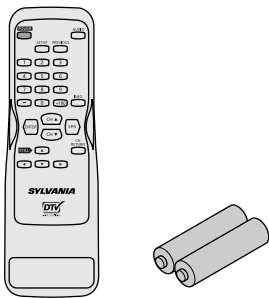

Owners manual (PART No.: OEMN02308)

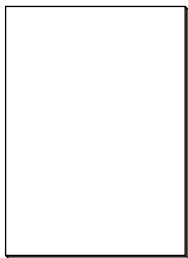

Installing batteries

- 1 Unsnap the battery cover from the back of the remote control.

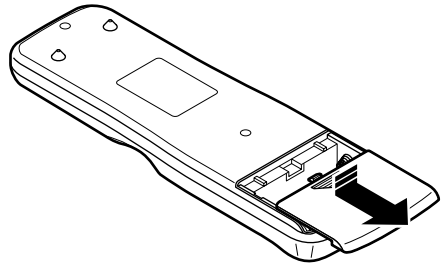

- 2 Install two AA batteries making sure the polarity (+ / -) direction is correct.

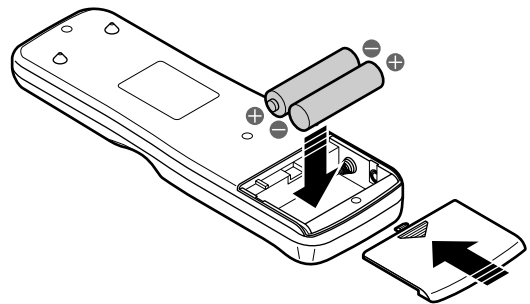

NOTE:

When replacing batteries, make sure to replace them in pairs.

- 3 Snap the battery cover back.

CAUTION:

- Do not mix battery types.
(alkaline and manganese)
- Do not recharge, short-circuit, heat, burn or disassemble batteries.

A NOTE ABOUT RECYCLING

This product's packaging materials are recyclable and can be reused. Please dispose of any materials in accordance with your local recycling regulations.

Batteries should never be thrown away or incinerated but disposed of in accordance with your local regulations concerning chemical wastes.

Reference to SETUP menu

SETUP WIZARD

(Refer to page 25 through page 29.)



Language for screen (1/8)
(Refer to page 25.)

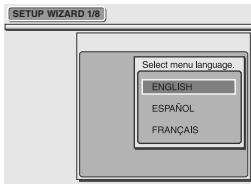

Channel scanning (2/8)
(Refer to page 26.)

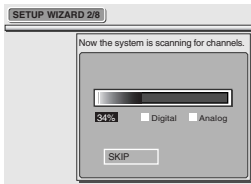

Daylight savings time (DST) (3/8)
(Refer to page 26.)

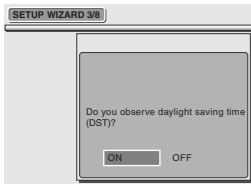

Time zone (4/8)
(Refer to page 26.)



Setting the clock (Manual) (5/8)
(Refer to page 27.)



Setting the clock (Auto) (6/8)
(Refer to page 28.)

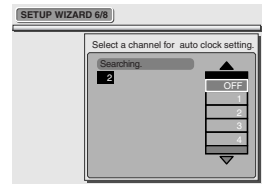

Screen ratio (7/8)
(Refer to page 29.)



Display mode (8/8)
(Refer to page 29.)

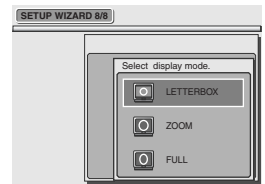

CHANNEL

DISPLAY

(Refer to page 43, 46, 49, 51.)

(Refer to page 54, 56.)

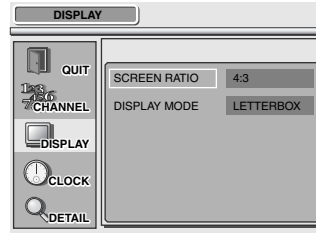
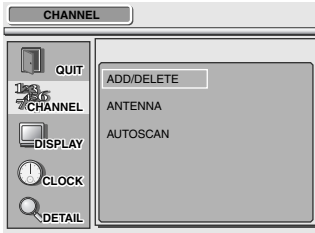

Adding channels /
Deleting channels
(Refer to page 43, 46.)

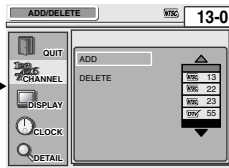

Selecting screen formats
(Screen ratio)
(Refer to page 54.)

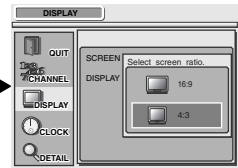

Adjusting antenna
(Refer to page 49.)

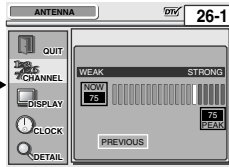

Selecting screen formats
(Display mode)
(Refer to page 56.)

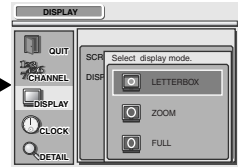

Receiving channels (Autoscan)
(Refer to page 51.)

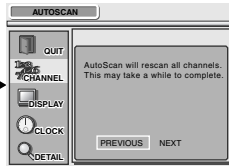

CLOCK

(Refer to page 59, 60, 62, 64.)

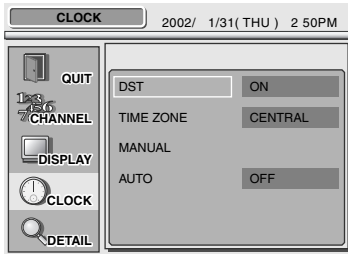

Setting the clock (Daylight Savings Time)
(Refer to page 60.)

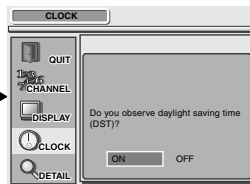

Setting the clock (Time Zone)
(Refer to page 60.)

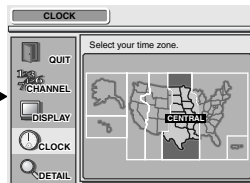

Setting the clock (Manual)
(Refer to page 62.)



Adjusting the clock automatically
(Refer to page 64.)



DETAIL

(Refer to page 66, 69, 70, 71, 73, 77, 81, 84.)

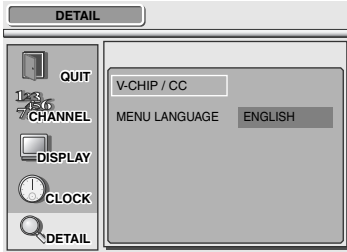

Setting for V-CHIP/CC
(Refer to page 69.)

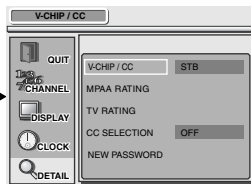

V-CHIP/CC password window
(Refer to page 70.)

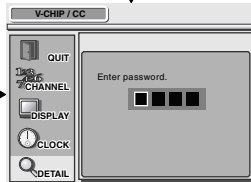

Choosing the screen language
(Refer to page 84.)



Setting for V-CHIP/CC
(Refer to page 71.)

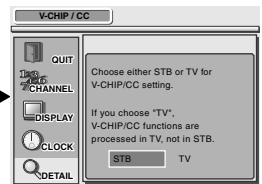

Setting MPA A rating
(Refer to page 73.)

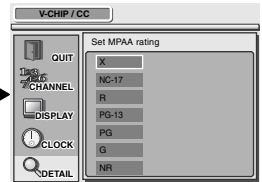

Setting TV rating
(Refer to page 77.)

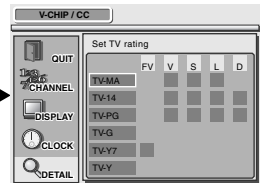

Setting CC options
(Refer to page 81.)

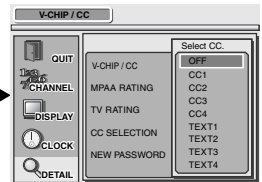

Setting a new password
(Refer to page 66.)

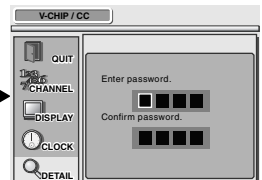

Connections to antenna

Use a standard antenna cable to connect the wall jack to the ANT IN Jack on STB.

STB connection to the antenna

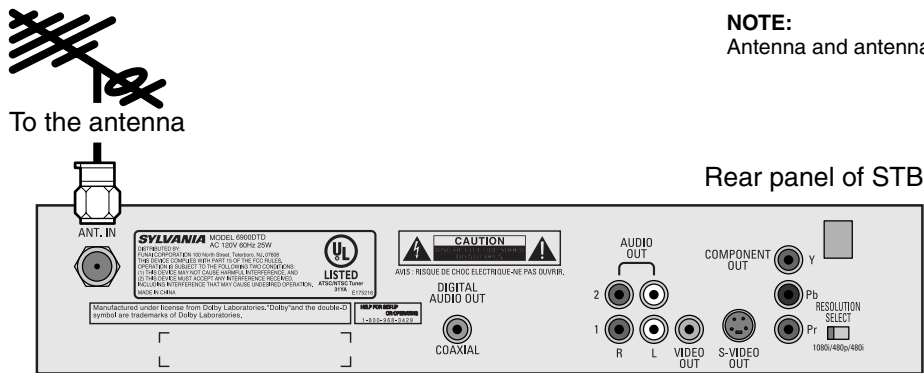

WHEN CONNECTING TO CABLE BOX ALSO:

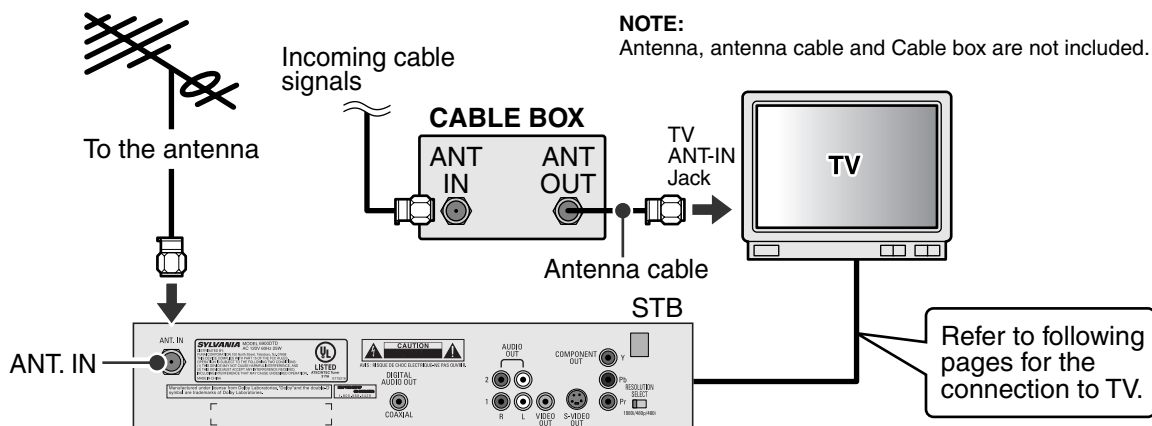

- 1 Use a standard antenna cable to connect the wall jack to the ANT IN Jack on STB.
- 2 Use an incoming cable to connect to an antenna input jack on the cable box.
- 3 Use a standard antenna cable to connect an antenna output jack on the cable box to an antenna input jack on the TV.
- 4 After completing the connection to TV, plug the AC power cord of the TV into the AC outlet, then turn the TV on.
- 5 Select the output channel from the cable box e.g., ch3 or ch 4.

NOTE:

Refer to the TV owner's manual for further information.

- 6 Plug the AC power cord of STB into the AC outlet, then turn STB on.

Note to the Cable TV System Installer :

This reminder is provided to call the Cable TV system installer's attention to Article 820-40 of the National Electrical Code, which provides guidelines for proper grounding - in particular, specifying that the cable ground shall be connected to the grounding system of the building, as close to the point of cable entry as possible.

Connections to other devices

There will be various ways of connecting STB to other devices. Make your connection according to your choice of devices, screen format, and sound format. You will find some sample connections in the following pages.

- All jacks on STB will not need to be connected.
- When you change the connections, all devices should be turned off.
- Refer to each owner’s manual for further information on other devices.



STB connection using COMPONENT video output to TV

e.g.: Connection to HDTV

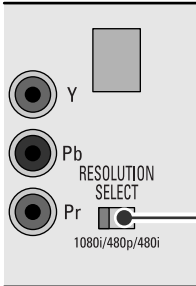
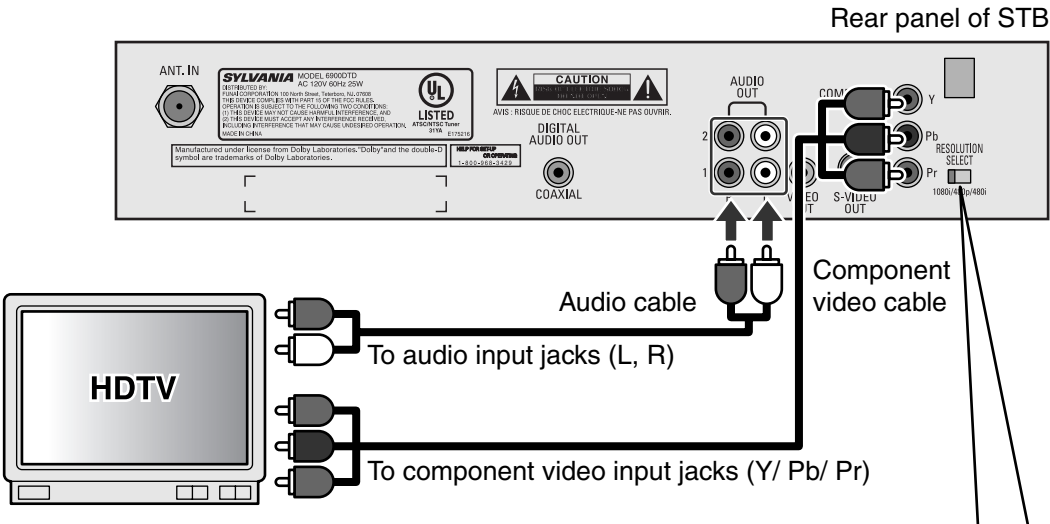
NOTE:
Component video cable and audio cable are not included.



Resolution Selection Switch (1080i, 480p, 480i)
Refer to the TV owner s manual for the video resolution of your TV.

TV Format	Position of Resolution Selection Switch	
1080i	 1080i/480p/480i	If your TV is capable of displaying 1080i, then select 1080i as shown.
480p	 1080i/480p/480i	If your TV is capable of displaying 480p, then select 480p as shown.
480i	 1080i/480p/480i	If your TV is capable of displaying 480i, then select 480i as shown.

- 1** Use a standard antenna cable to connect the wall jack to the ANT IN jack on STB.
- 2** Use a standard audio cable to connect the audio output jacks (L, R) of STB to the audio input jacks (L, R) on the TV.
NOTE:
If your TV is monaural (MONO) and has only one audio jack, use a standard audio cable (white) to connect the audio output jack (white) on STB to the audio input jack (white) on the TV. The red cable and jack will not be used.
- 3** Use a component video cable to connect the component video output jacks (Y/ Pb/ Pr) on STB to the component video input jacks (Y/ Pb/ Pr) on the TV.
- 4** Set the video resolution selection switch to “1080i.”
NOTE:
For the capability of your TV and further information, refer to TV owner’s manual.
- 5** After completing the connection to the TV, plug the AC power cord of the TV into the AC outlet, then turn the TV on.
- 6** Set the TV to the input mode.
NOTE:
Refer to the TV owner’s manual for further information.
- 7** Plug the AC power cord of STB into the AC outlet, then turn STB on.

Connections

STB connection using S-VIDEO output to SDTV

NOTE:
S-video cable and audio cable are not included.

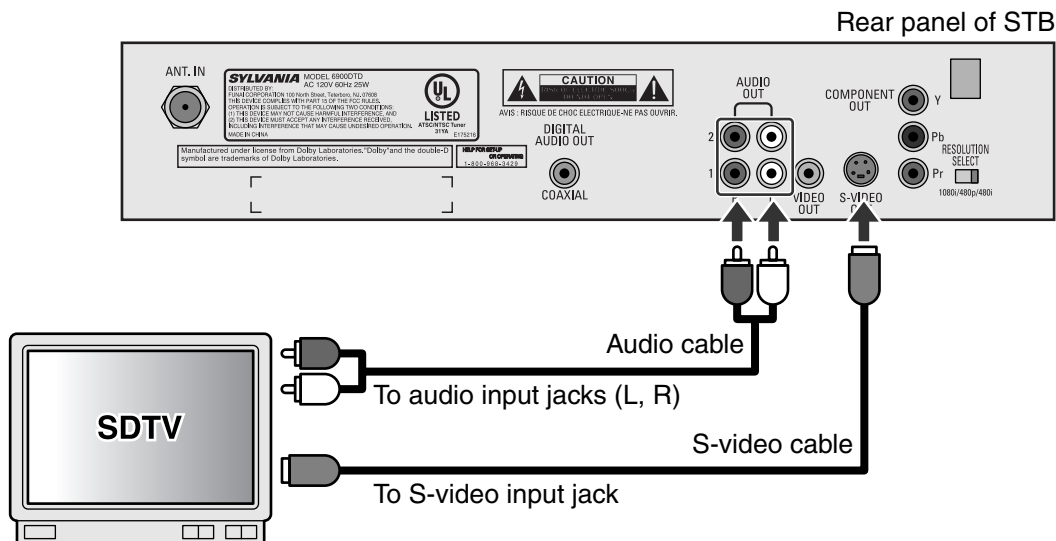

- 1 Use a standard antenna cable to connect the wall jack to the ANT IN jack on STB.
- 2 Use a standard audio cable to connect the audio output jacks (L, R) of STB to the audio input jacks (L, R) on the TV.
- 3 Use an S-video cable to connect the S-VIDEO output jack on STB to an S-video input jack on the TV.
- 4 Set the resolution selection switch to “480i.”
- 5 After completing the connection to the TV, plug the AC power cord of the TV into the AC outlet, then turn the TV on.
- 6 Set the TV to the input mode.
NOTE:
Refer to the TV owner’s manual for further information.
- 7 Plug the AC power cord of STB into the AC outlet, then turn STB on.

NOTE:
When using an S-video cable to connect, the resolution of the video signal output will always be 480i.

STB connection using VIDEO output to SDTV

NOTE:

Audio cable and video cable are not included.

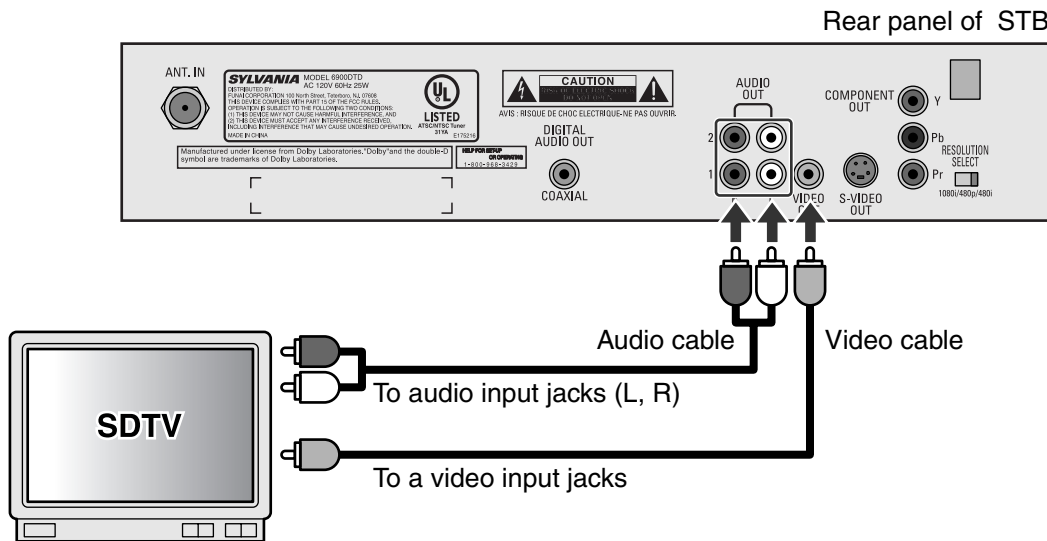

- 1 Use a standard antenna cable to connect the wall jack to the ANT. IN jack on STB.
- 2 Use a standard audio cable to connect the audio output jacks (L, R) of STB to the audio input jacks (L, R) on the TV.

NOTE:
If your TV is monaural (MONO) and has only one audio jack, connect a standard audio cable (white) from the audio output jack (white) on STB to an audio input jack (white) on the TV. The red cable and jack will not be used.
- 3 Use a standard video cable to connect the video output jack on STB to a video input jack on the TV.
- 4 Set the resolution selection switch to “480i.”
- 5 After completing the connection to the TV, plug the AC power cord of the TV into the AC outlet, then turn the TV on.
- 6 Set the TV to the input mode.

NOTE:
Refer to the TV owner’s manual for further information.
- 7 Plug the AC power cord of STB into the AC outlet, then turn STB on.

NOTE:

When using a standard video cable to connect, the resolution of the video signal output will always be 480i.

Connections

STB connection to a standard stereo system

NOTE:

Component video cable and audio cable are not included.

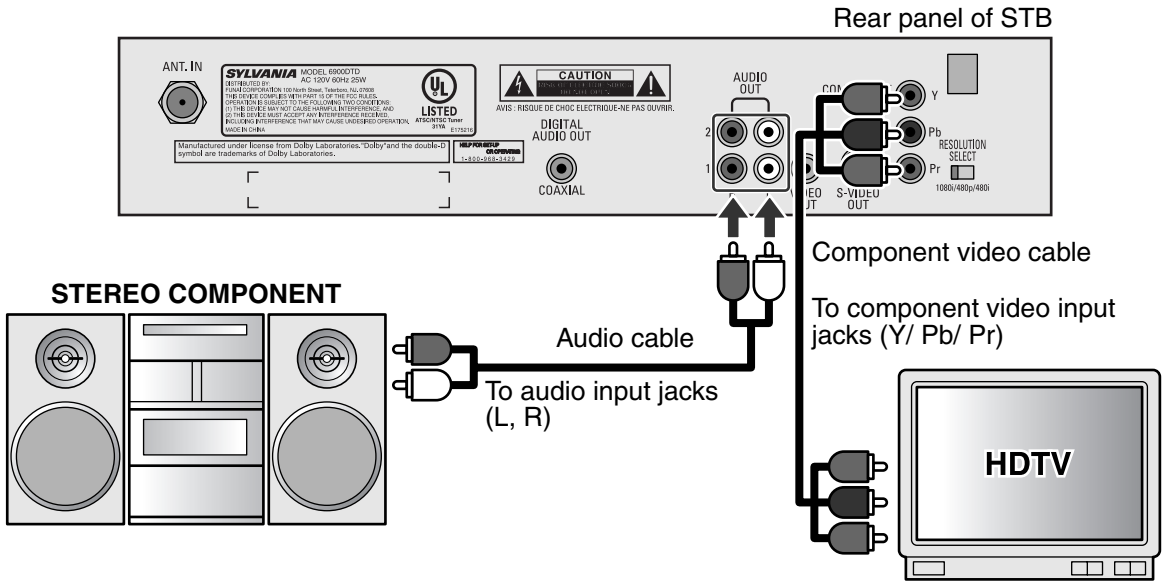

- 1 Use a standard antenna cable to connect the wall jack to the ANT. IN jack on STB.
- 2 Use a standard audio cable to connect the audio output jacks (L, R) on STB to the audio input jacks (L, R) on the stereo.
- 3 Connect STB and the TV with a video cable.
NOTE:
Refer to the pages describing the connection to TV.
- 4 Set the video resolution selection switch to “1080i.”
NOTE:
For the capability of your TV and further information, refer to TV owner’s manual.
- 5 Plug the AC power cord of the stereo into the AC outlet, then turn the stereo on.
- 6 Set the stereo to the input mode to which you connected the audio from the STB.
NOTE:
Refer to the stereo owner’s manual for further information.
- 7 Plug the AC power cord of STB into the AC outlet, then turn STB on.

STB connection to a decoder with Dolby® Digital

NOTE:

Coaxial digital audio cable and component video cable are not included.

Rear panel of STB

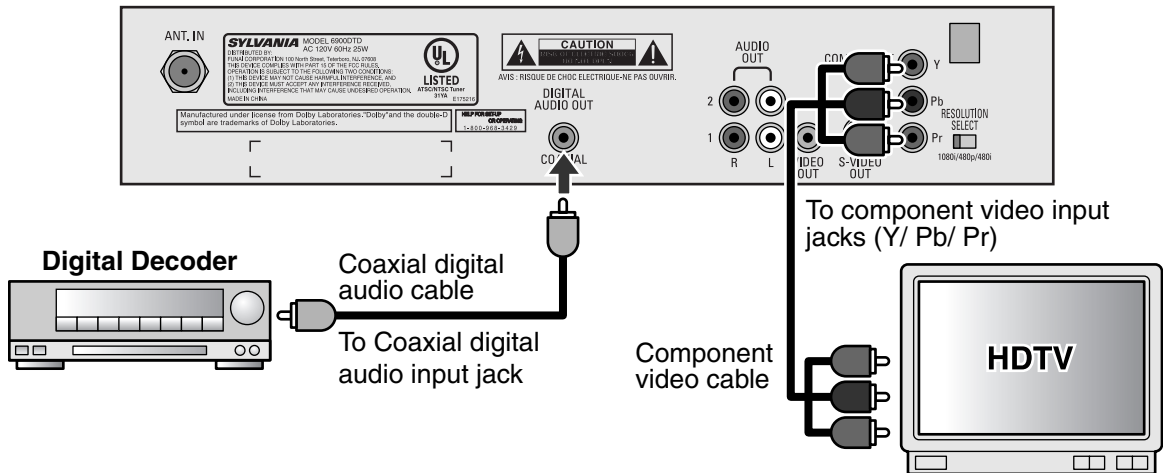

- 1 Use a standard antenna cable to connect the wall jack to the ANT. IN jack on STB.
- 2 Connect a coaxial digital audio cable (purchase locally) from DIGITAL AUDIO (COAXIAL) output jack on STB to a coaxial digital audio input jack on the digital decoder.
- 3 Connect STB and the TV with a video cable.

NOTE:

Refer to the pages describing the connection to TV for connecting to the TV.

- 4 Set the video resolution selection switch to “1080i.”

NOTE:

For the capability of your TV and further information, refer to TV owner’s manual.

- 5 Plug the AC power cord of the decoder into an AC outlet, then turn the decoder on.

- 6 Set the decoder to the input mode.

NOTE:

Refer to the decoder owner's manual for further information.

- 7 Plug the AC power cord of STB into an AC outlet, then turn them on.

NOTE:

STB will output the sound from the DIGITAL AUDIO (COAXIAL) output only when receiving a digital broadcast.

Dolby® information:

Manufactured under license from Dolby Laboratories. "Dolby" and the double-D symbol are trademarks of Dolby Laboratories.

Connections

STB connection to TV and Video devices (VCR, DVD recorder, etc)

e.g.: Connection to VCR

NOTE:

Audio cables and video cables are not included.

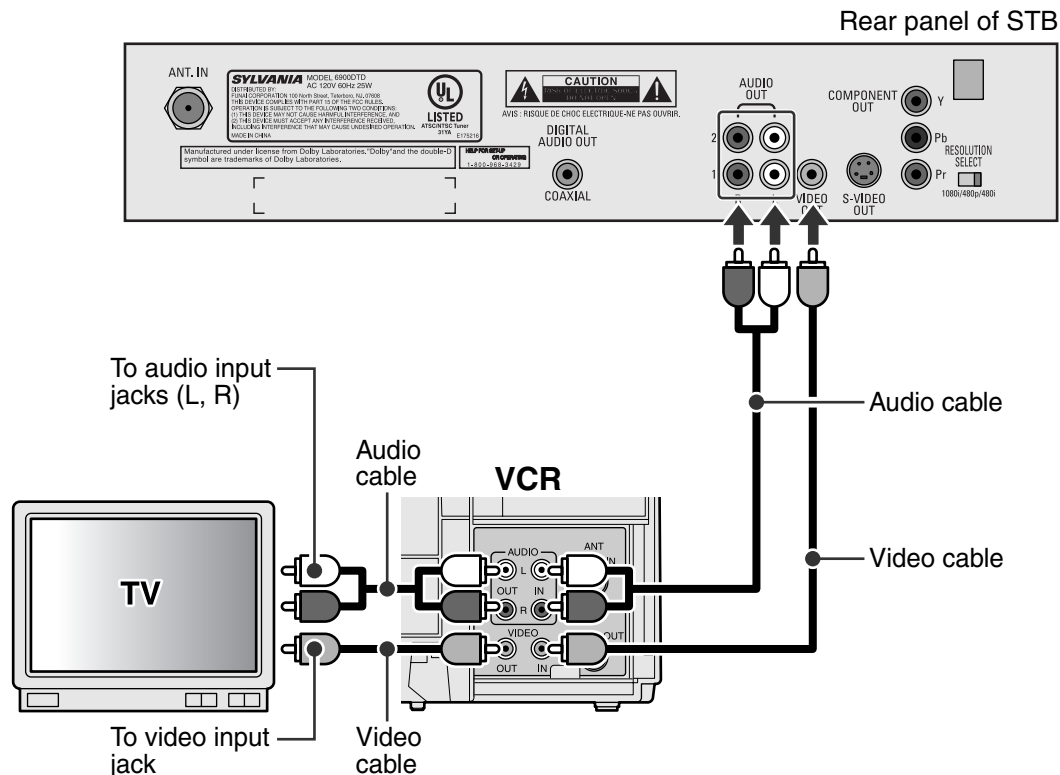

- 1 Use a standard antenna cable to connect the wall jack to the ANT IN jack on STB.
- 2 Use a standard audio cable to connect the set of audio output jacks (L, R) on STB to the set of audio input jacks (L, R) on the VCR.

NOTE:

If your VCR is monaural (MONO) and has only one audio jack, use a standard audio cable (white) to connect the audio output jack (white) on STB to the audio input jack (white) on the VCR. The red cable and jack will not be used.

- 3 Use a standard video cable to connect the video output jack on STB to the video input jack on the VCR.
- 4 Set the video resolution selection switch to “480i.”

NOTE:

No matter where the switch is, the video resolution with this connection will be always 480i. For screen ratio and display mode, the settings in Setup menu will be effective. For the capability of your TV and further information, refer to TV owner’s manual.

- 5 Use a standard video cable to connect the video output jack on the VCR to the video input jack on the TV.
- 6 Use a standard audio cable to connect the set of audio output jacks (L, R) on the VCR to the audio input jacks (L, R) on the TV.
- 7 Plug all AC power cords into AC outlets, then turn all devices on.
- 8 Set the TV and VCR to input mode.

NOTE:

Refer to the owner’s manuals of the TV and the VCR for further information.

NOTE:

When using a standard video cable to connect, the resolution of the video signal output will always be 480i.

Initial setup

SETUP WIZARD

SETUP WIZARD is the very convenient menu for you to make the initial settings of STB.

When STB is turned on for the first time after connecting the AC power cord, SETUP WIZARD is displayed on the screen automatically. You can complete the following items for the initial Setups through this menu.

- Language for screen
- Channel Scanning
- Daylight savings time (DST)
- Time zone
- Year/ date/ time
- Clock
- Screen ratio and display mode

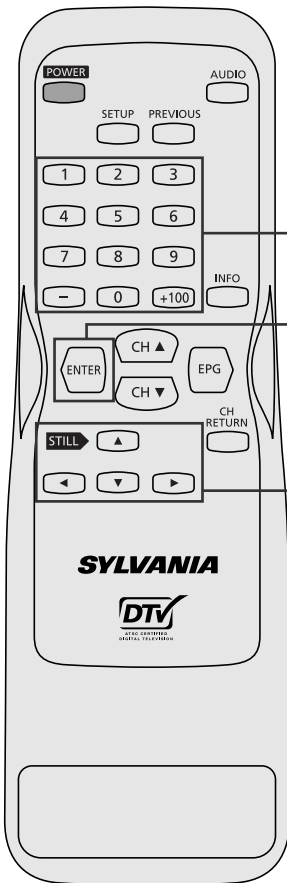

1 SETUP WIZARD will appear.

Screen:



2 Select SETUP using ◀/▶ navigation buttons, then press ENTER.

- SETUP WIZARD 1/8 will appear.

Remote:

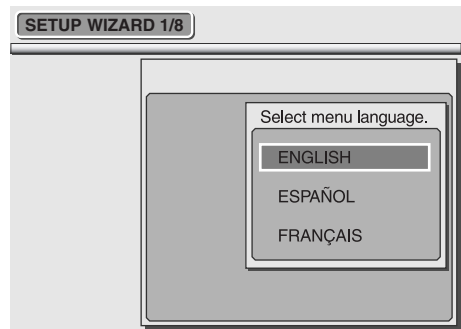
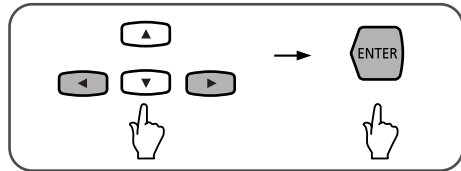

3 Initial Setups (Setup Wizard)

Initial Setups (Setup Wizard)

3 Select a desired language using ▲/▼ navigation buttons, then press ENTER.

- The selected language will be activated.
- SETUP WIZARD 2/8 will appear.

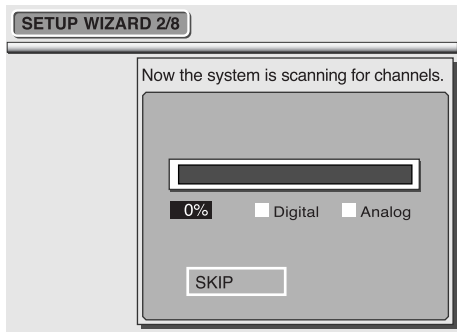
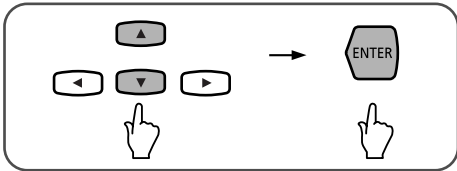

4 STB starts scanning channels.

- Wait until the scanning is complete.
- When the scanning is complete, "100%" will be indicated in the box, then the next screen appears.

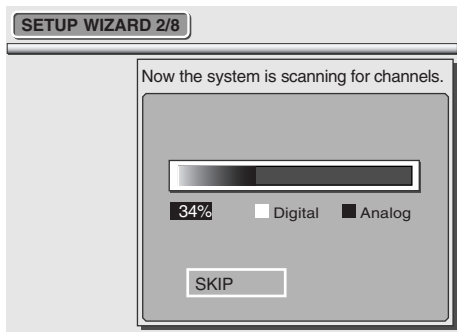

To skip the scanning:

Press ENTER.

5 SETUP WIZARD 3/8 will appear.

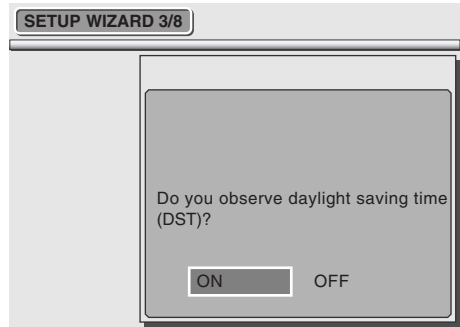

6 Select ON or OFF for Daylight Savings Time (DST) using ◀/▶ navigation buttons, then press ENTER.

- SETUP WIZARD 4/8 will appear.

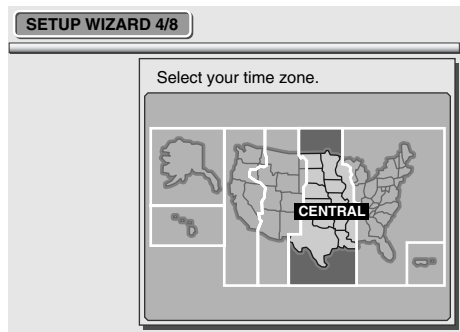
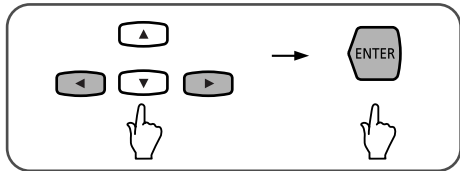

7 Select the desired time zone using ▲/▼ /◀/▶ navigation buttons, then press ENTER.

- SETUP WIZARD 5/8 will appear.

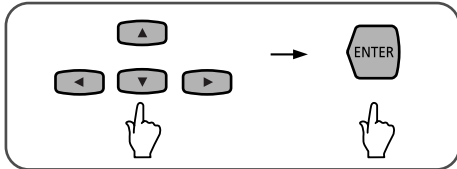

NOTE :
Refer to “INFORMATION on Time Zones ” on page 61.

8 Enter YEAR, DATE and TIME using ▲/▼ /◀/▶ navigation buttons or number buttons.

- Every time you enter a number, press ENTER to move the cursor.
- When going back and forth, press ◀/▶ navigation buttons to move the cursor.

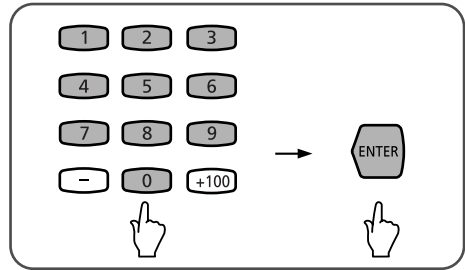

or

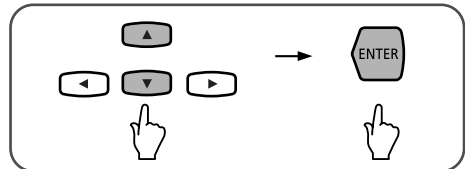

NOTE:
After all information is entered, the cursor will move to SET.

TIP:
To enter the YEAR, enter the last 2 digits of the year. The year will be entered. (e.g., Enter “03” using number buttons; 2003 will be shown.)

Initial Setups (Setup Wizard)

9 Press ENTER when the cursor is on SET.

- Your settings will be activated.
- SETUP WIZARD 6/8 will appear, then STB will start searching channels with Automatic Clock Adjustments to keep the time correct.

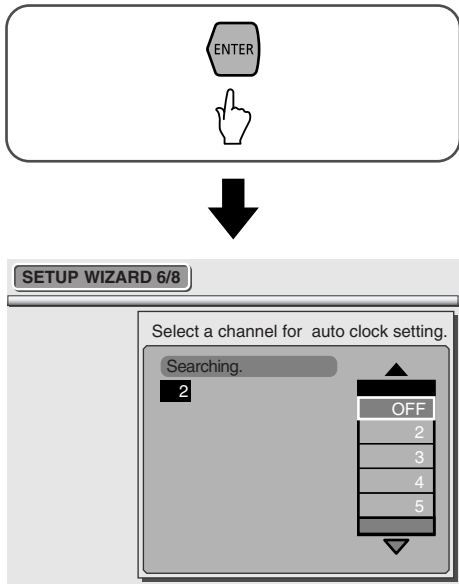

10 Select the desired channel to search from the channel map using ▲/▼ navigation buttons.

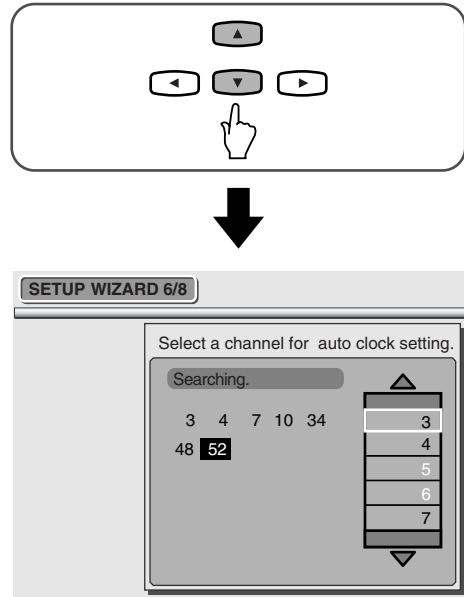

NOTE:

The channel numbers with clock data will become black in the channel map.

NOTE:

▲ : Indicates that there are more channels above or below.

▲ : Indicates the top or bottom of the channel map.

When not using the auto-clock setting:

Select OFF on the channel map, then press ENTER.

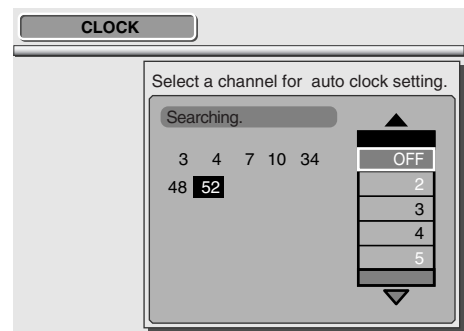

TIP:

OFF is located at the top of the channel map. Keep pressing ▲ navigation button to search.

11 Press ENTER.

- SETUP WIZARD 7/8 will appear.

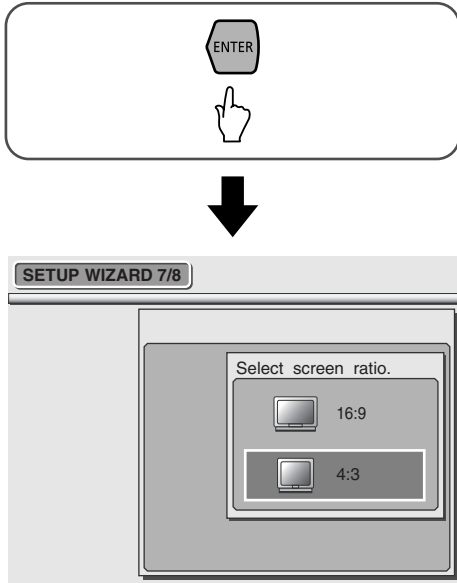

12 Select the desired screen ratio using ▲ / ▼ navigation buttons, then press ENTER.

- SETUP WIZARD 8/8 will appear.

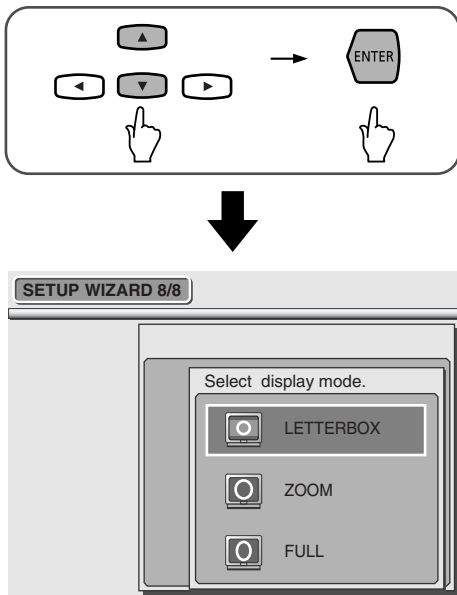

NOTE:

Refer to “Selecting screen formats” on page 54 for further information.

13 Select the desired display mode using ▲ / ▼ navigation buttons, then press ENTER.

- SETUP WIZARD is completed. STB will now start receiving broadcasts.

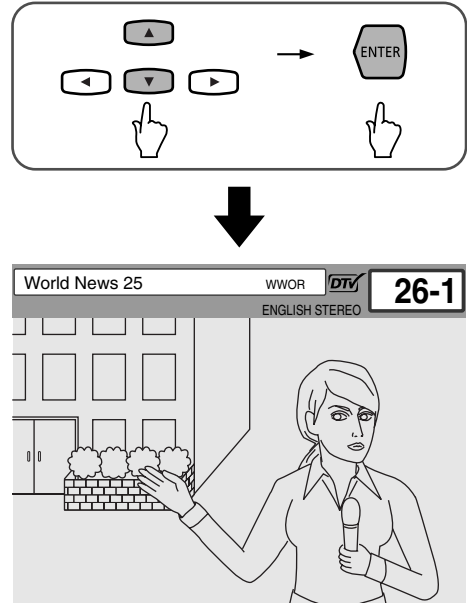

NOTE:

Refer to “Selecting screen formats” on page 54 for further information.

Watching TV

STB is capable of receiving analog (NTSC format) and digital (ATSC format) broadcasts.

All available channels from any of these broadcast sources can be tuned in using the CH ▲/▼ buttons and number buttons on your remote control.

Each channel number consists of a main channel number and a sub-channel number.

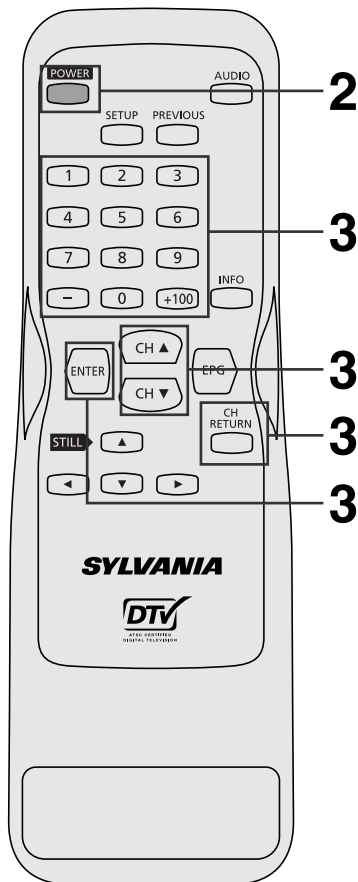

1 Turn the TV on and select the input to which the STB is connected to.

2 Turn the STB on.

- The power indicator on the STB front panel will blink and light up.

Remote:

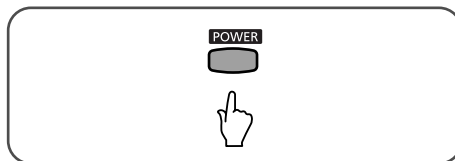

3 Selecting a desired channel.

When using CH ▲/▼ buttons:

- Press CH ▲ button to tune a higher channel number.
- Press CH ▼ button to tune a lower channel number.

TIP:

Be sure to complete AUTOSCAN in SETUP WIZARD or in the SETUP menu so that STB receives all channels available to be watched (ATSC and NTSC).

When using number buttons (E.g., entering 26-1):

1. Enter the main channel number, press the “-” button, then enter the sub-channel number.

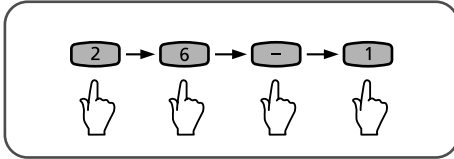

NOTE:

Every channel number consists of a main channel and a sub-channel.

Screen:

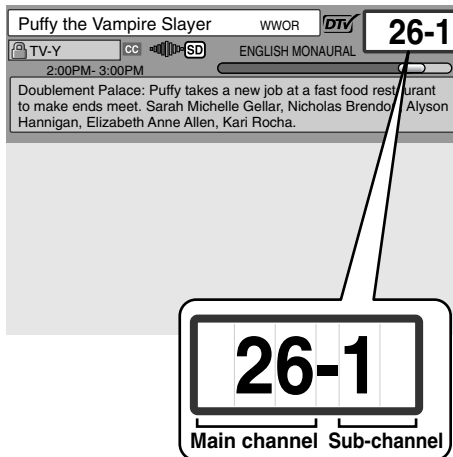

TIP:

When entering a 3-digit channel number, press the “+100” button first, then enter the main channel number.

Be sure to press the “-” button before entering the sub-channel number.

2. Press ENTER.

- STB will tune in channel 26-1, and the program being broadcast will be displayed.

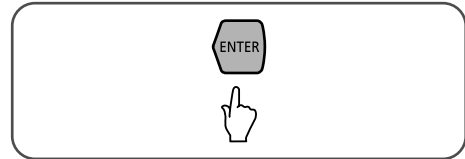

NOTE:

Sub-channel numbers from NTSC are always 0.

When selecting only with a main channel number (E.g., entering 55):

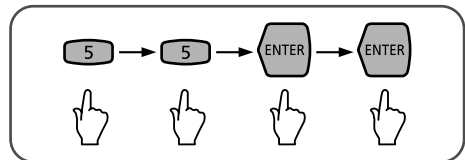

- X appears momentarily as an alternate sub-channel, then STB receives the sub-channel with the smallest sub-channel number from either NTSC or ATSC.

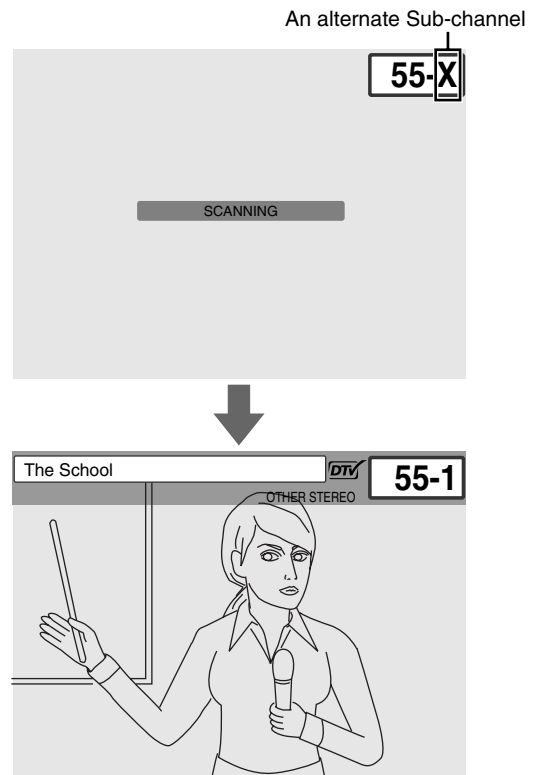

Basic Operation

When returning to the channel you were last watching:

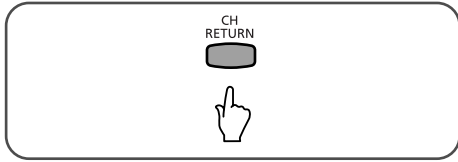

- STB will tune back in the channel you were last watching.

About sub-channel broadcasting:

There may be different programs being broadcast on sub-channels through a single channel from ATSC. You can watch each sub-channel program being broadcast by selecting one of the sub-channels.

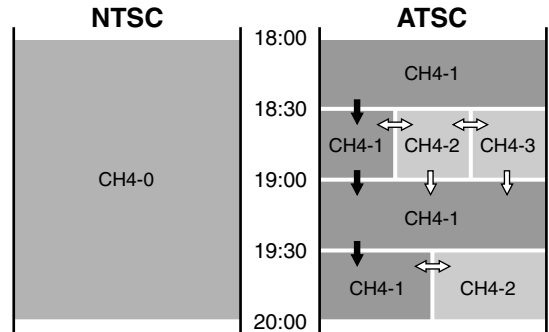

➔ : changes automatically

⇔ : change manually by pressing CH▲/▼ button on your remote control.

NOTE:

NO SIGNAL will appear on the screen after the sub-channel broadcast is over.

You will need to change the channel to continue watching another TV program.

Channel banner

The channel banner provides you with information on the channel you have selected.

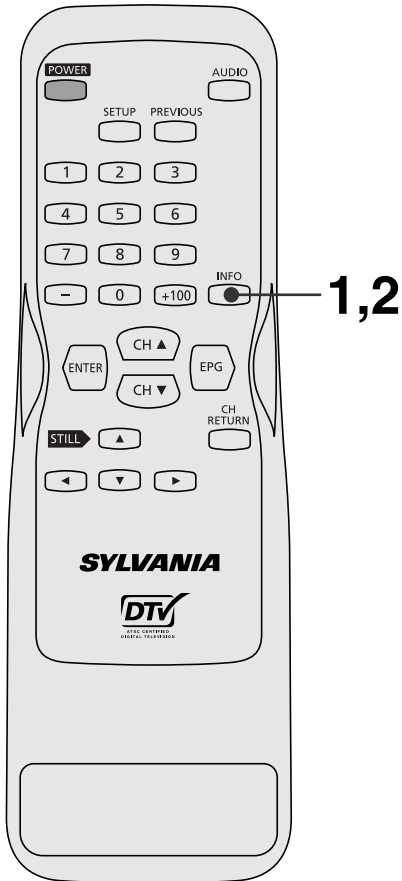

1 Press INFO to display a channel banner.

- Channel information will appear in the channel banner.

Remote:

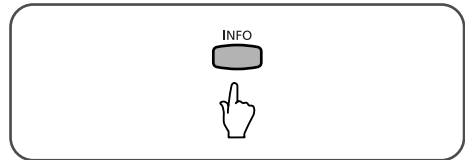

Screen:

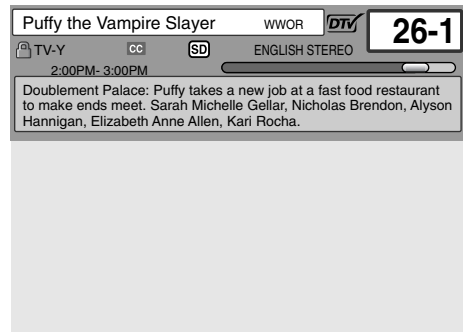

2 Press INFO to clear.

NOTE:

When tuning in a channel from NTSC:
The indicators “Program title” and “Program description” are always as shown below.

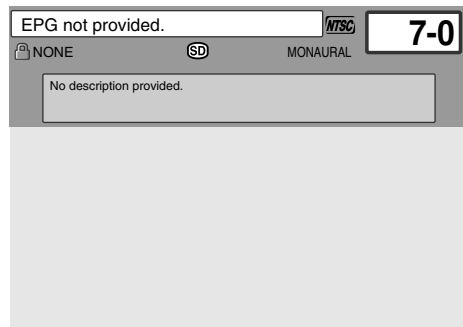

Components of Channel Banner

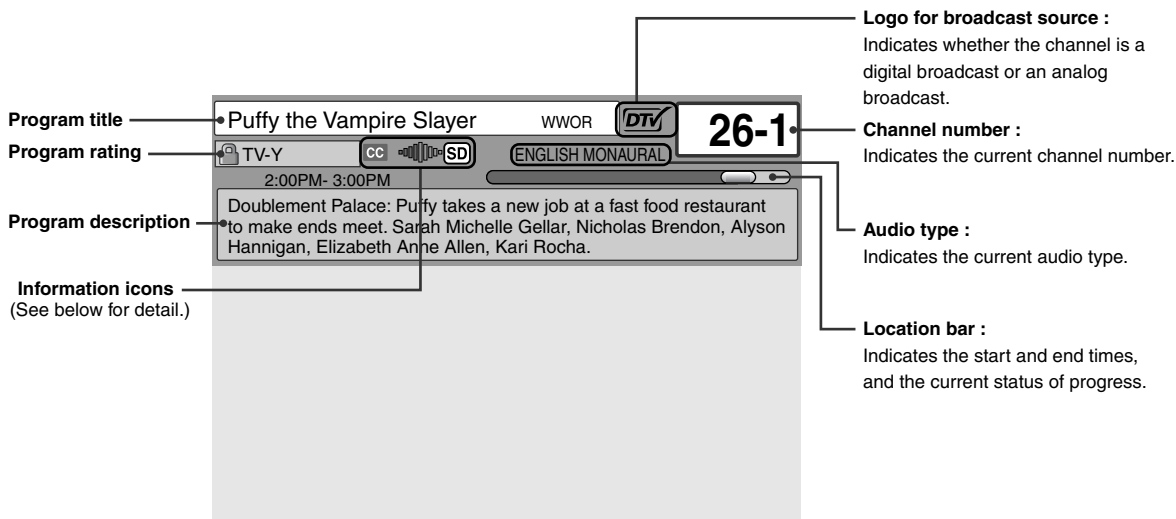

Information icons



DTV:
Indicates that you are tuning in a digital channel.



NTSC:
Indicates that you are tuning in an analog channel.



HD (High Definition):
Indicates that the program being broadcast has a high definition signal with screen ratio 16:9.



SD (Standard Definition):
Indicates that the program being broadcast has standard definition signal with screen ratio 16:9.



SD (Standard Definition):
Indicates that the program being broadcast has standard definition signal with screen ratio 4:3.



LOCK:
Indicates that the current program is blocked according to your V-CHIP setting.



CC (Closed Caption):
Indicates that the program being broadcast is available with closed captioning.



V-CHIP/CC:
Indicates that V-CHIP/CC has been set to TV.
Refer to "Setting for V-CHIP/CC" on page 69 for further information.

Choosing audio and language

When the channel you are tuning in provides alternate audio formats and languages, you can change to any alternate.

When you are tuning in ATSC, language and format can be set at the same time through an audio-map.

Audio map: (Only when tuning in ATSC)

Audio format and language outputs from a broadcasting station are stored in an audio-map. For example, when three language are available, the sequence below will repeat and the desired audio format and language can be set.

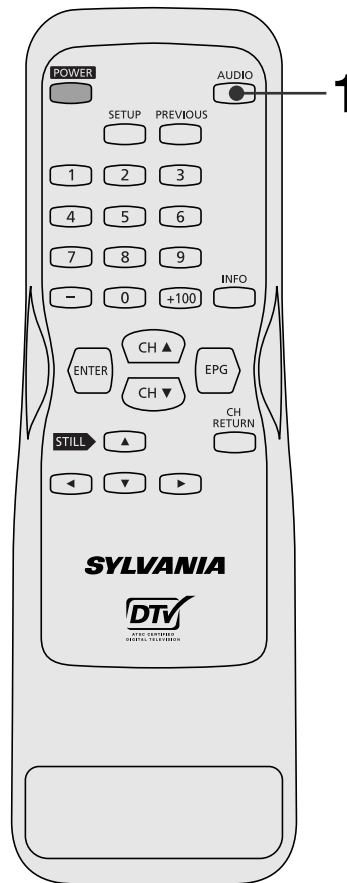
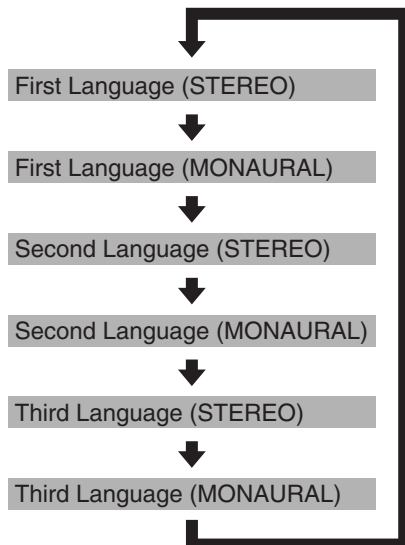

Basic Operation

1 Press AUDIO button.

Remote:



When tuning in NTSC:

The sequence will repeat as shown below when available.

Screen:

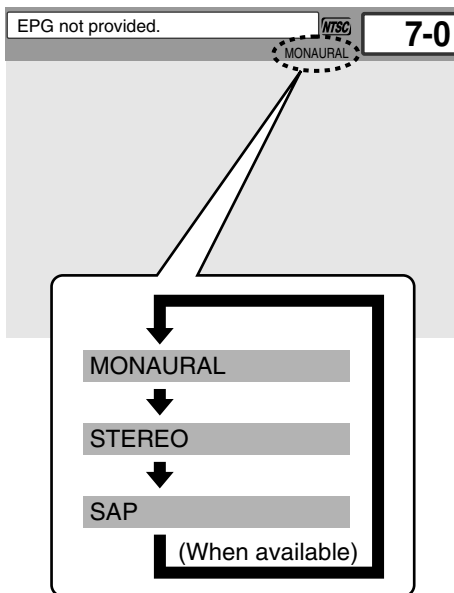

When tuning in ATSC:

The sequence will repeat according to audio-map when the AUDIO button is pressed.

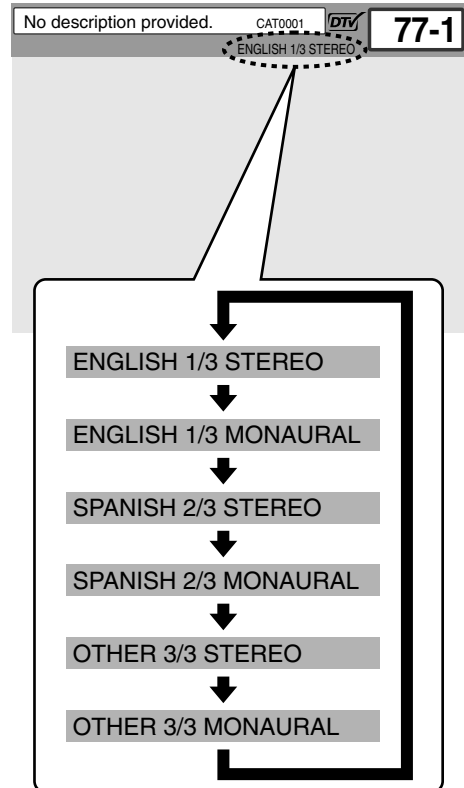

NOTE:

OTHER will be indicated when alternate languages are not English, Spanish, or French.

Picture Still

You can stop the picture on the screen anytime by pressing STILL ▲ button.

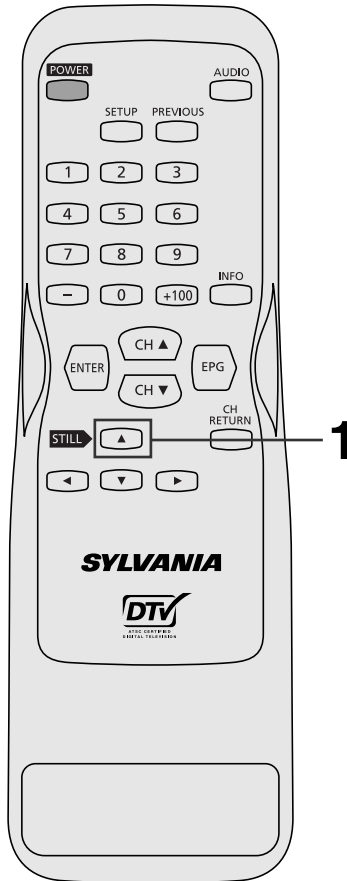

1 Press STILL ▲ button while watching TV.

- STILL will be indicated on the lower left while the picture is displayed.

Remote:

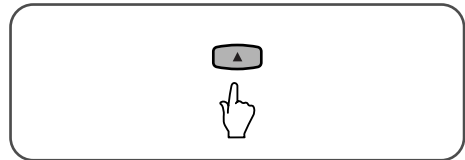

Screen:



NOTE:

During STILL, the programs audio will continue.

2 Press any button to quit.

- The picture currently being broadcast will appear.

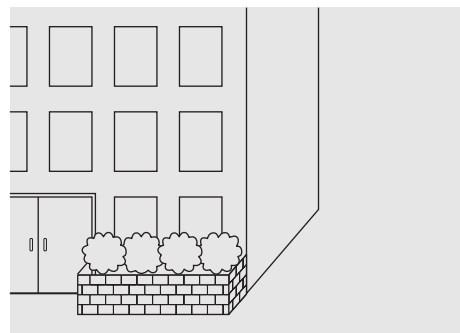

NOTE:

If the TV is left on STILL for a long period of time, the still image may cause a burn-in effect damaging the TV screen.

On screen messages

Some messages are displayed on the screen during channel changing or during programs.

NO SIGNAL

When STB cannot receive a channel signal, the whole screen becomes gray, then NO SIGNAL appears in the center. This may occur when:

- the signal is too weak
- the channel is not broadcasting
- the antenna cable is not connected

Screen:

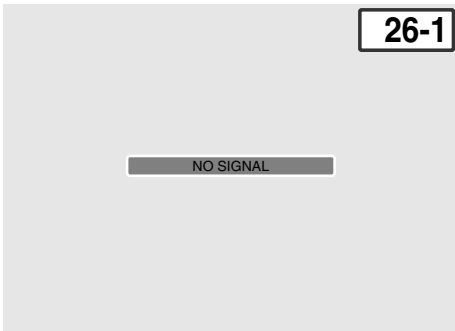

SCANNING

When STB is trying to receive a signal, the whole screen becomes gray, then SCANNING appears in the center.

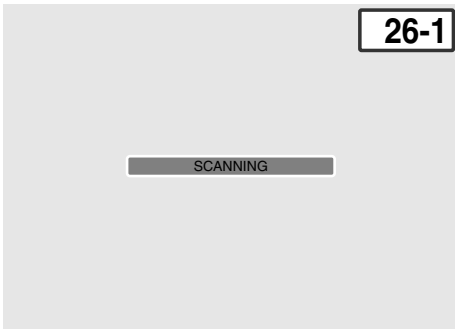

RESTRICTED PROGRAM

When you have set V-CHIP and you receive a program that meets any setting of yours, the whole screen becomes gray, then RESTRICTED PROGRAM appears in the center. Please refer to “Setting for V-CHIP/CC” on page 69 for further information.



NOTE:
Press INFO button to verify the rating of a program currently being received.

Remote:

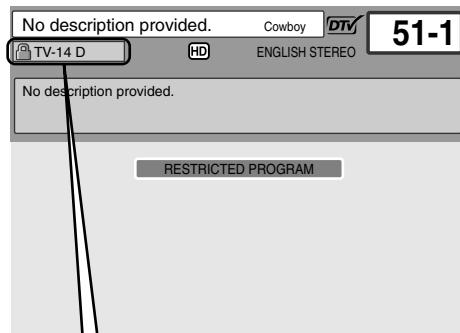
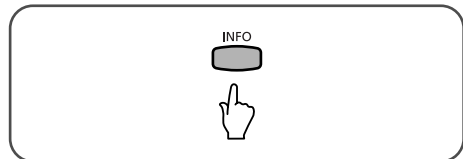

The rating of this program

Electronic Program Guide (EPG)

Electronic Program Guide (EPG) is an application for digital channels that lists current and scheduled programs that are or will be available on each channel and a short summary or commentary for each program.

EPG is the electronic equivalent of a printed television program guide. You can view a list of programs scheduled for from the next few hours up to the next seven days.

NOTE:

For displaying EPG, you will need to set TIME ZONE, DST, and MANUAL of CLOCK in SETUP WIZARD or in SETUP menu.

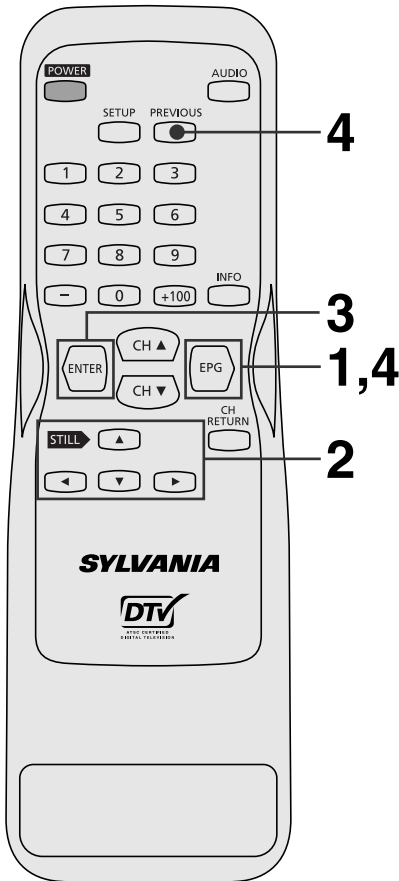

1 Press EPG button while watching TV.

- EPG will appear on the screen.

Remote:

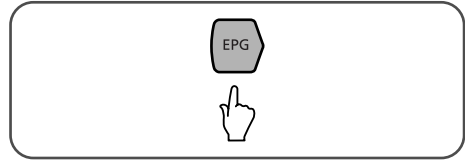

Screen:

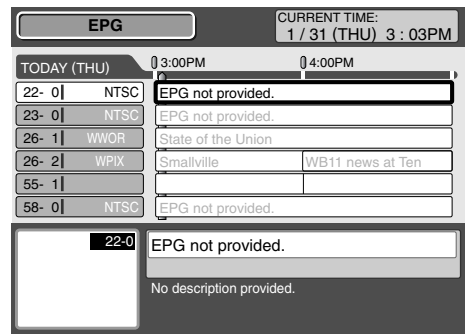

NOTE:

Refer to Components of Electronic Program Guide (EPG) for details on page 41.

Advanced Operation

2 Select the desired program using ▲/▼/◀/▶ navigation buttons.

- The cursor will move as you press any navigation button.

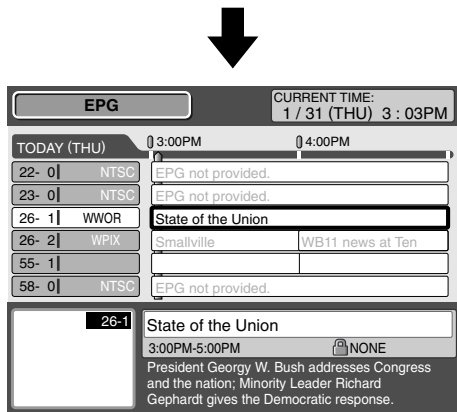
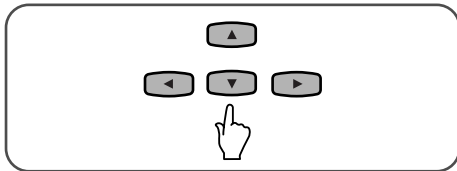

3 Press ENTER.

When selecting a program being broadcast:

- The selected program will appear.

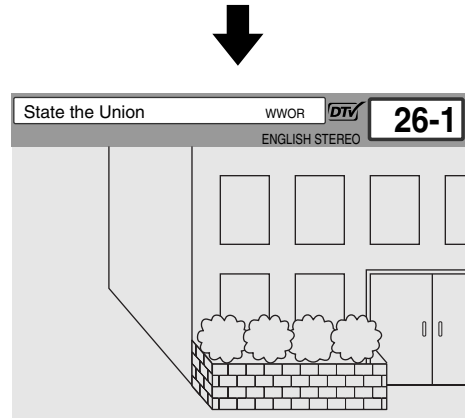
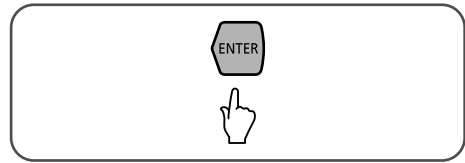

When viewing EPG for the next two hours up to the next seven days:

Press ▶ navigation button.

- EPG for the next two hours will appear.

NOTE:

By pressing ▶ navigation button, EPG will move ahead.

When going back to the previous page:

Press ◀ navigation button.

- The previous page of EPG will appear.

NOTE:

By pressing ◀ navigation button, EPG will move back.

When clearing EPG:

Press EPG or PREVIOUS.

The program previously watched will appear.

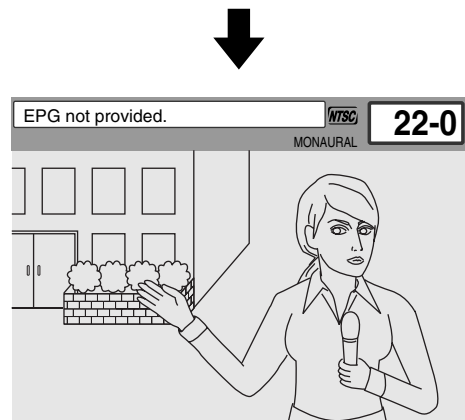
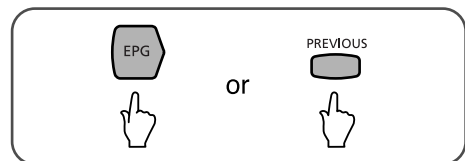

Components of Electronic Program Guide (EPG)

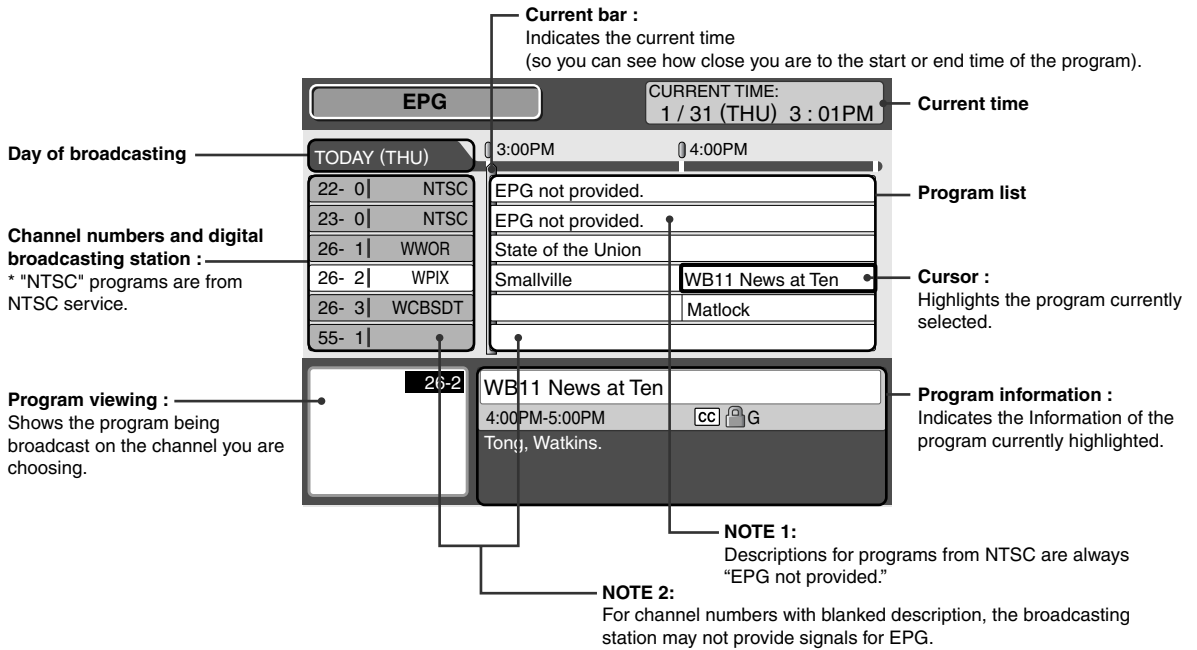

Information icons



LOCK:

Indicates that the current program is blocked according to your V-CHIP setting.



CC (Closed Caption):

Indicates that the program being broadcast is available with closed captioning.

Setup menu for preference



includes:

- **ADD / DELETE:**
You can add or delete channels in the channel map.
- **ANTENNA:**
You can verify and adjust the signal strength of each channel to get a clearer picture.
- **AUTOSCAN:**
You can get available channels automatically into the channel map by completing AUTOSCAN.



includes:

- **SCREEN RATIO:**
You can fit the screen ratio to your TV screen.
- **DISPLAY MODE:**
You can choose the display mode as you prefer.



includes:

- **Daylight Saving Time (DST):**
You can set the Daylight Savings Time (DST).
- **TIME ZONE:**
You can set the time zone.
- **MANUAL:**
You can set the clock manually.
- **AUTO:**
You can adjust the clock automatically using the channel clock data included in the signal from digital broadcast sources.



includes:

- **V-CHIP/ CC:**
You can make some settings for V-CHIP and closed caption including your own password.
- **MENU LANGUAGE:**
You can choose the language you prefer for the screen menu.

Adding channels

ADD/ DELETE

You can add channels in the channel map.

ADD:

You can add desired channels to the channel map. Once you add channels to a channel map, you will be allowed to select the channels in order using CH ▲ / ▼ buttons.

NOTE:

When you add digital and analog channels with the same main channel number, you will need to add each channel.

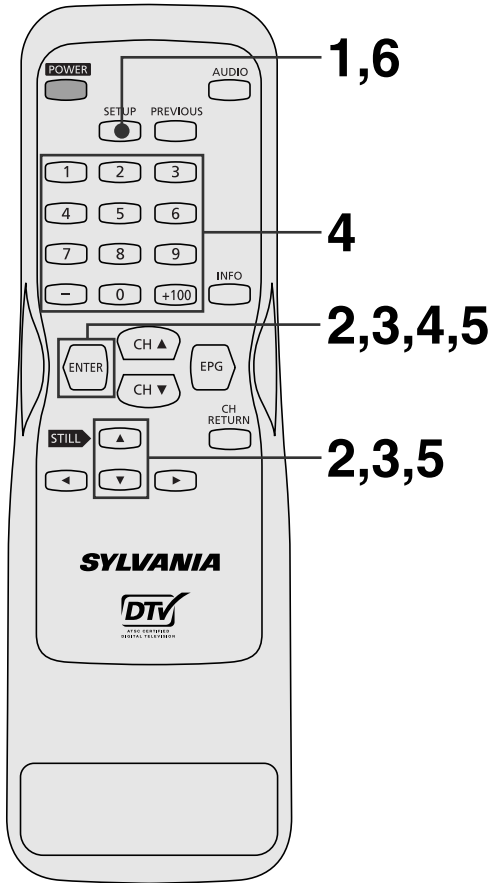

E.g., When adding the digital channel 26-1.

1 Press SETUP to display SETUP menu.

- SETUP menu will appear.

Remote:

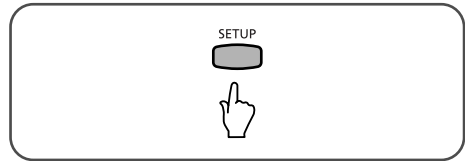

Screen:

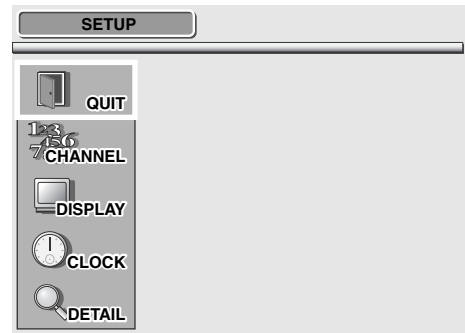

Advanced Operation

2 Select CHANNEL using ▲/▼ navigation buttons, then press ENTER.

- CHANNEL menu will appear.

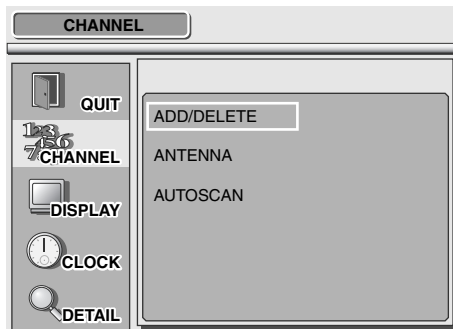
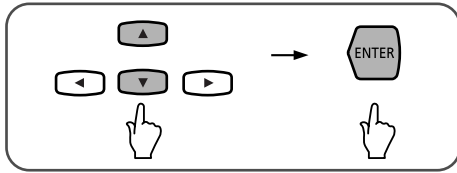

4 To add, first enter the digital channel number 26-1.

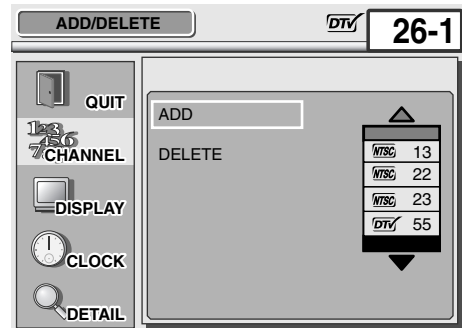
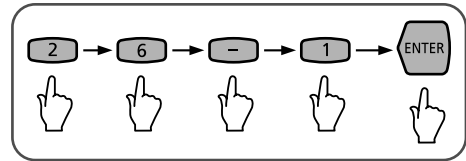

3 Select ADD/ DELETE using ▲/▼ navigation buttons, then press ENTER.

- ADD/ DELETE menu will appear.

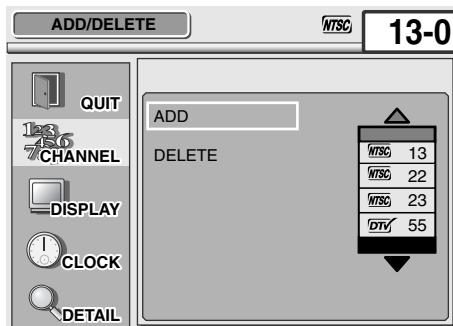
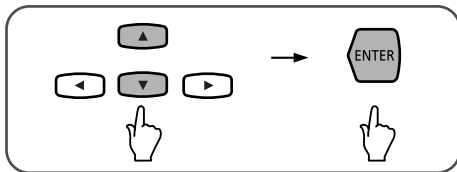

TIP:

You can enter simply 26 (main channel number) for a digital channel.

NOTE:

For an analog channel, a sub-channel number must be entered.

5 Select ADD using ▲/▼ navigation buttons, then press ENTER.

- 26-1 will be added to the channel map.

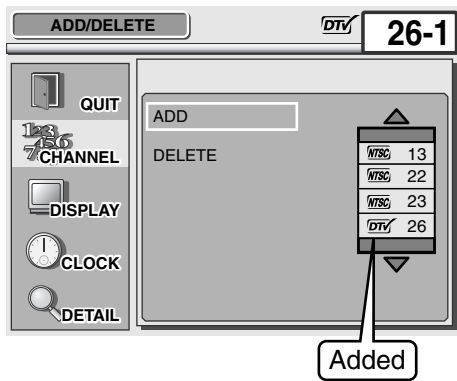
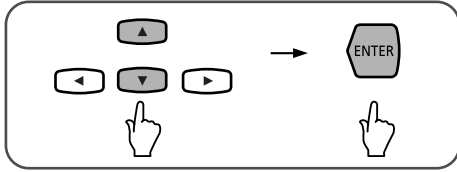

INFORMATION on Channel Map

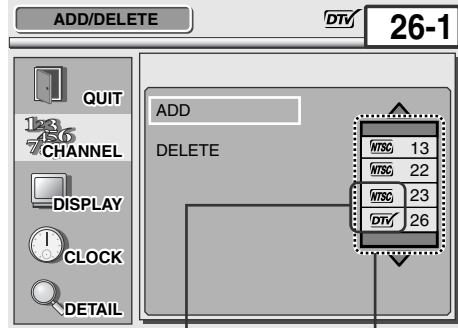

Channel map

NTSC : Indicates an analog channel.

DTV : Indicates a digital channel.

NOTE:

Digital channels can be added only with main channel numbers. When the digital channel added to a channel-map has sub-channels, however, the sub-channels can be selected using CH ▲/▼ buttons.

To continue adding:

Repeat Steps 4 and 5 to add channels.

6 Press SETUP to exit SETUP menu.

Deleting channels

ADD/ DELETE

You can add and delete channels in the channel map.

DELETE :

You can delete channels from the channel-map.

NOTE:

When you delete digital and analog channels with the same main channel number, you will need to delete each channel.

NOTE:

Once you delete channels from a channel-map, you cannot select those channels using CH ▲ / ▼ buttons.

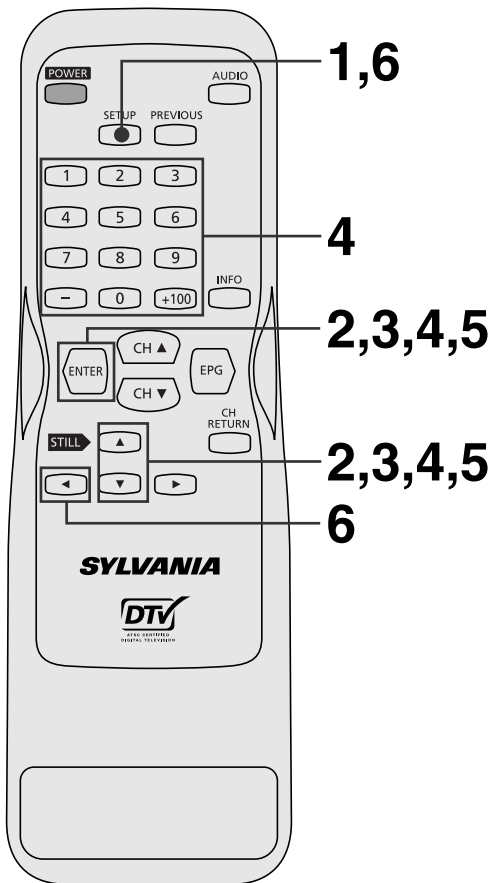

E.g., To delete the digital channel 26-1.

1 Press SETUP to display SETUP menu.

- SETUP menu will appear.

Remote:

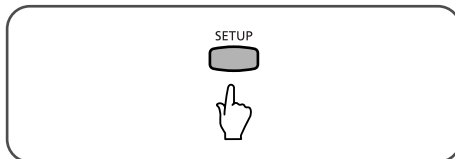

Screen:

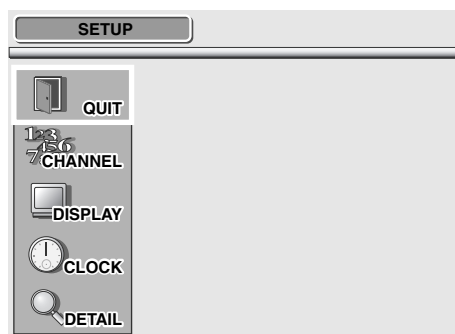

2 Select CHANNEL using ▲ / ▼ navigation buttons, then press ENTER.

- CHANNEL menu will appear.

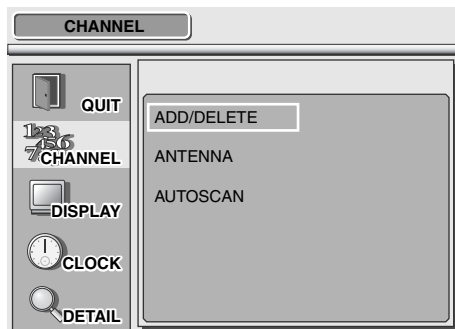
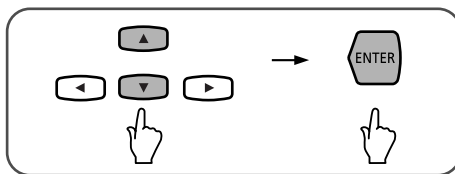

3 Select ADD/DELETE using ▲/▼ navigation buttons, then press ENTER.

- ADD/DELETE menu will appear.

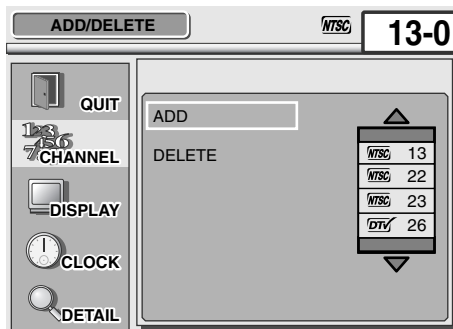
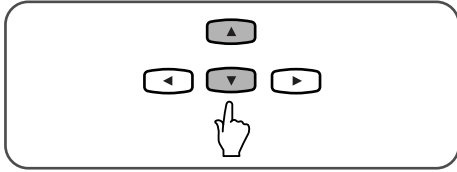

4 Select DELETE using ▲/▼ navigation buttons, then press ENTER.

- The cursor will move to the channel map.

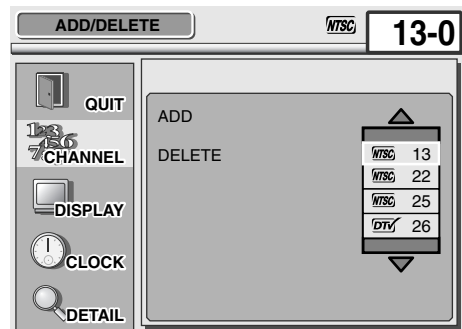
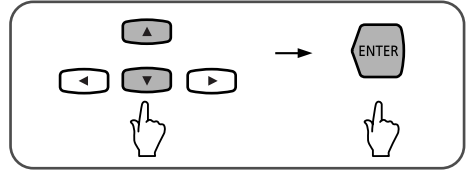

Advanced Operation

5 Select the digital channel number 26 using ▲/▼ navigation buttons.

- 26-1 will be indicated in the box at the top of the screen.

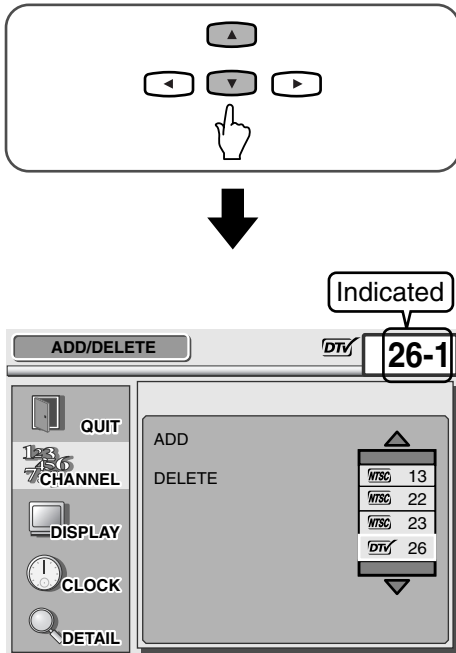

TIP:

When adding a channel number previously deleted, add the channel number by the steps in the ADD menu or renew the whole channel map with the AUTOSCAN menu.

6 Press ENTER when the cursor is on the digital channel 26.

- The digital channel number 26 will be deleted.

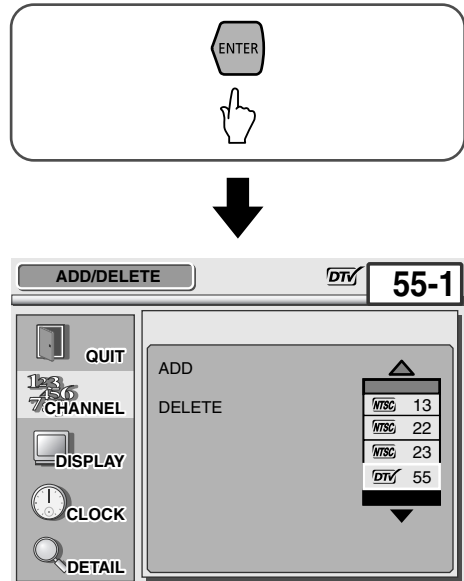

To continue deleting:

Repeat Steps 5 and 6.

NOTE:

▲ : Indicates that there are more channels above or below.

▲ : Indicates the top or bottom of the channel map.

7 Press SETUP to exit SETUP menu.

Adjusting antenna

ANTENNA

You can verify the signal strength of each channel to get a clearer picture for both digital and analog broadcasts.

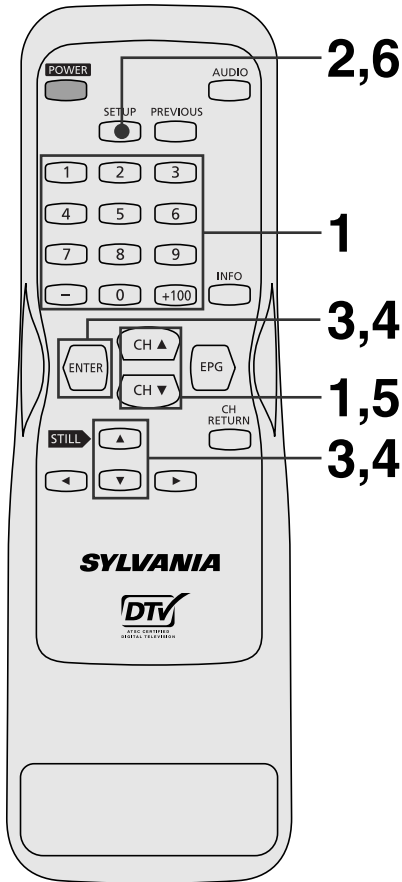

E.g., when adjusting the digital channel 26-1.

1 Select channel 26-1 to adjust using number button or CH ▲ / ▼ buttons.

- Channel 26-1 will be tuned in.

Remote:

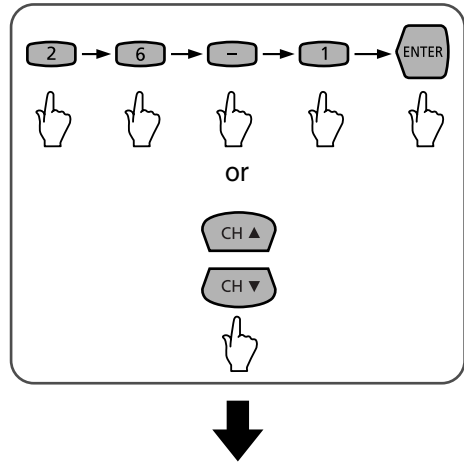

Screen:

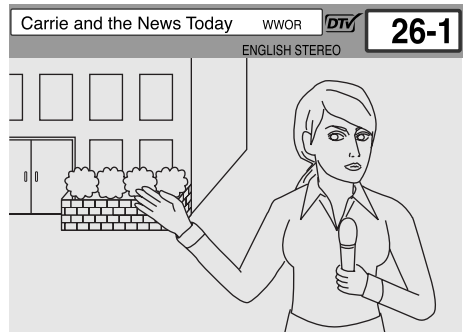

Advanced Operation

2 Press SETUP to display SETUP menu.

- SETUP menu will appear.

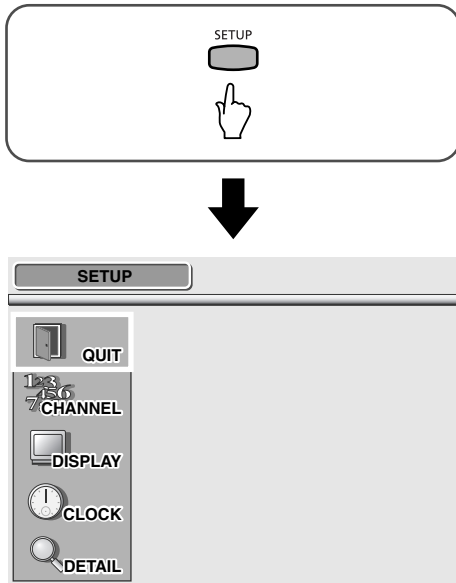

- ANTENNA menu will appear, then STB starts receiving the signal strength of the channel.

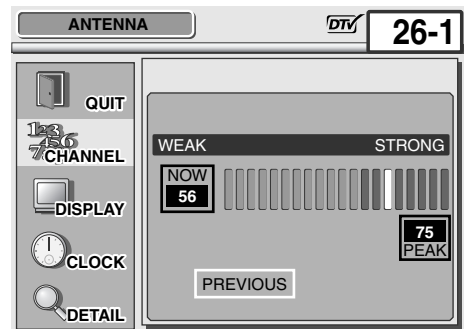
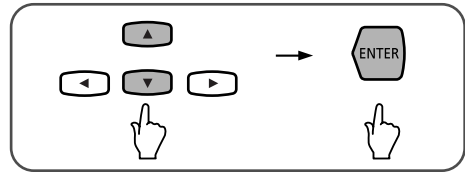

3 Select CHANNEL using ▲/▼ navigation buttons, then press ENTER.

- CHANNEL menu will appear.

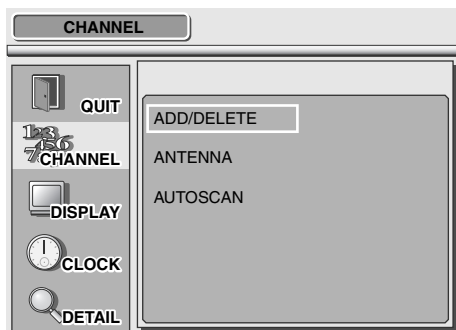
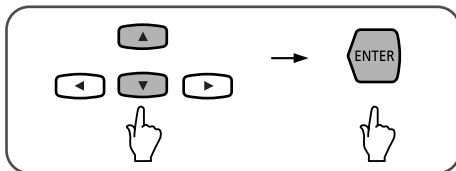

5 Adjust the antenna direction to get the best reception.

- A status bar stretches to the right according to the signal strength.
- The value will be indicated on the left of the status bar so that you can adjust the antenna direction.

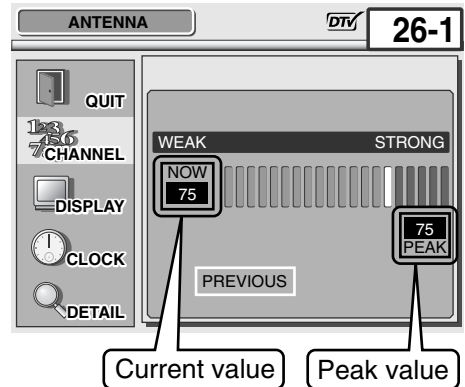

4 Select ANTENNA using ▲/▼ navigation buttons, then press ENTER.

When adjusting other channels continuously:

Select the desired channel for adjusting using CH ▲ / ▼ buttons, then adjust.

6 Press SETUP to exit SETUP menu.

Receiving channels

AUTOSCAN

STB has the convenient function to get available channels automatically.

AUTOSCAN is capable of receiving available channels, both analog and digital, and storing those channels in a channel map.

Channels once stored in a channel map can be selected using CH ▲ / ▼ buttons.

CAUTION:

If AUTOSCAN is skipped, digital channels may not be received even when channel numbers are correctly entered.

NOTE:

We recommend a complete AUTOSCAN to receive all available channels properly.

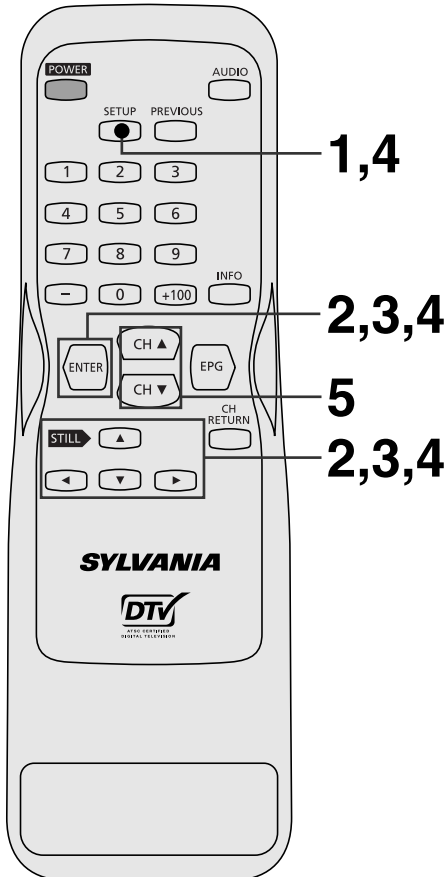

1 Press SETUP to display SETUP menu.

- SETUP menu will appear.

Remote:

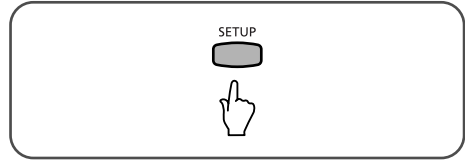

Screen:

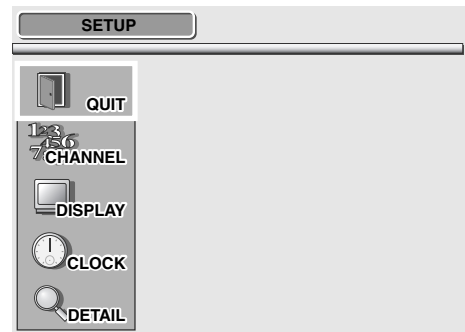

2 Select CHANNEL using ▲ / ▼ navigation buttons, then press ENTER.

- CHANNEL menu will appear.

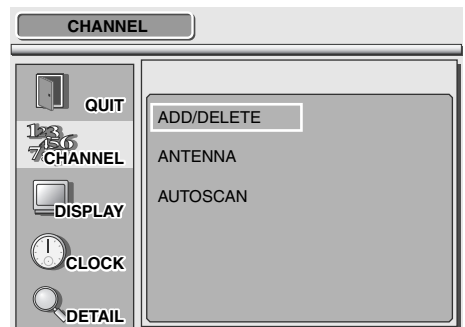
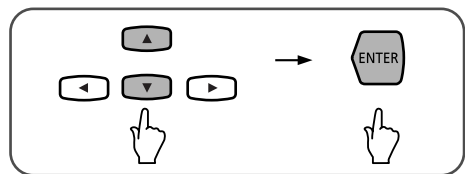

Advanced Operation

3 Select AUTOSCAN using ▲/▼ navigation buttons, then press ENTER.

- AUTOSCAN menu will appear.

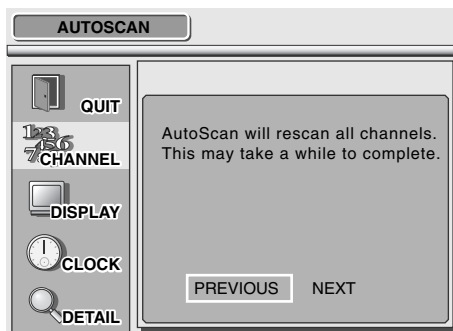
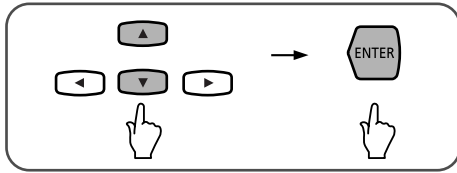

4 Select NEXT using ◀/▶ navigation buttons, then press ENTER.

- Scanning window will appear, then STB will start scanning for all available channels.

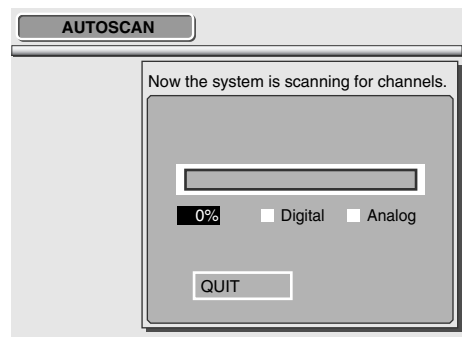
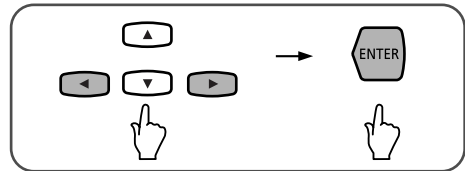

NOTE:

It will depend on the location, however, it usually takes approximately 3 minutes to complete.

To cancel AUTOSCAN during scanning:

Press SETUP or ENTER to cancel.

- AUTOSCAN CANCELLED will appear on the screen.

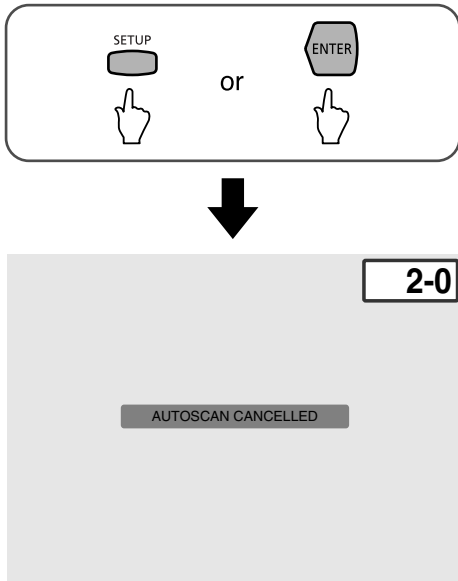

CAUTION:

If AUTOSCAN is cancelled during scanning, some channels not yet scanned may not be received. It is recommended to complete AUTOSCAN.

5 AUTOSCAN is complete.

- SETUP menu will go off automatically.
- STB will receive broadcasts right after AUTOSCAN is complete.

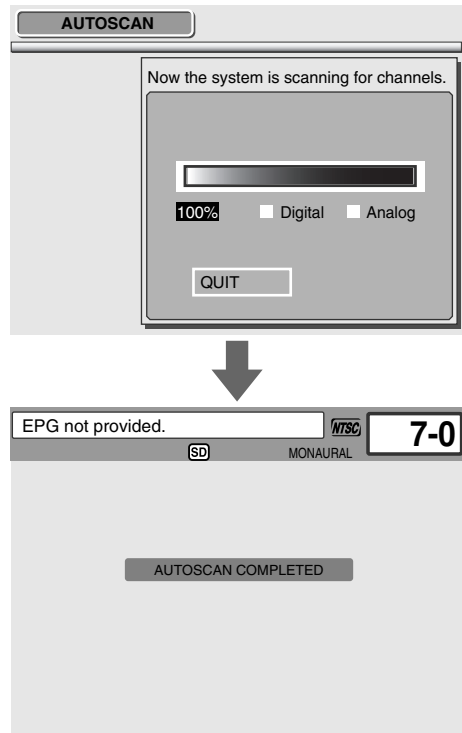

NOTE:

Press CH ▲ / ▼ buttons to verify whether STB is receiving channels being broadcast.

When NO SIGNAL appears on the screen:

Verify the antenna connection, then complete AUTOSCAN again.

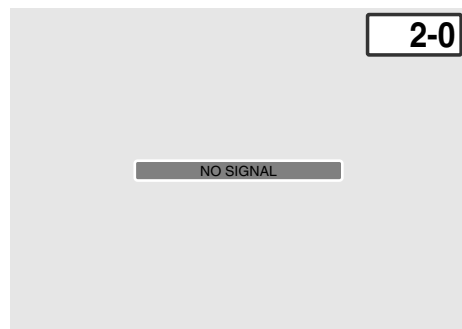

Selecting screen formats

STB allows you to select a screen ratio and a display mode (aspect ratio) to match the formats of the program being broadcast and your TV screen. You can also change to aspect ratios you prefer to watch.

SCREEN RATIO

There are two screen ratios used in manufacturing TVs. These are standard TV format (4:3), and widescreen format (16:9).

NOTE:

Aspect ratio is the format for broadcasting and displaying which are defined by the ratio of the screen width to height.

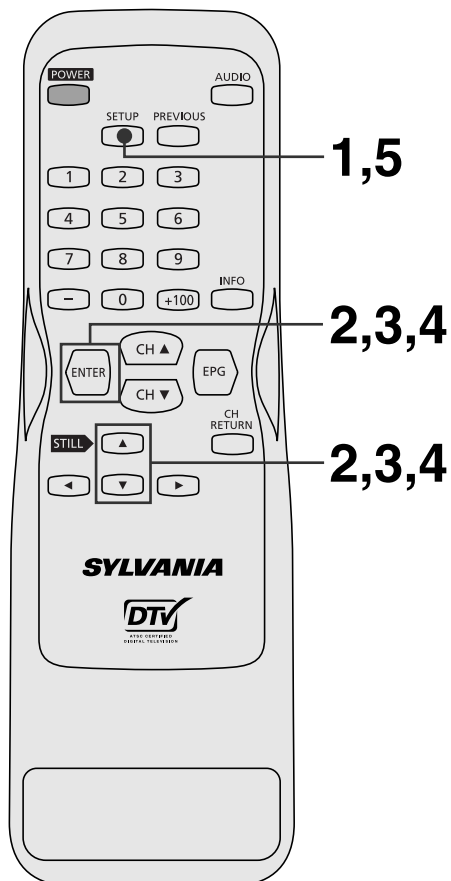

1 Press SETUP to display SETUP menu.

- SETUP menu will appear.

Remote:

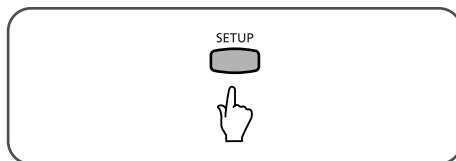

Screen:

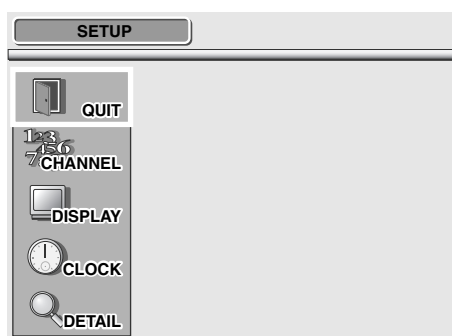

2 Select DISPLAY using ▲/▼ navigation buttons, then press ENTER.

- DISPLAY menu will appear.

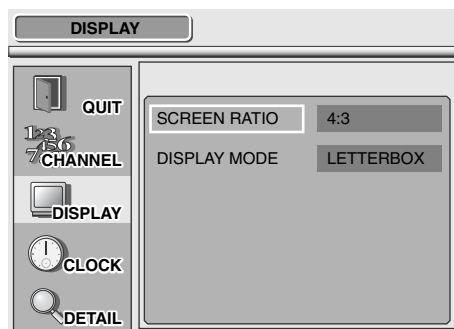
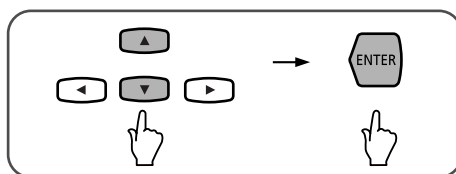

3 Select SCREEN RATIO using ▲/▼ navigation buttons, then press ENTER.

- Screen ratio options will appear.

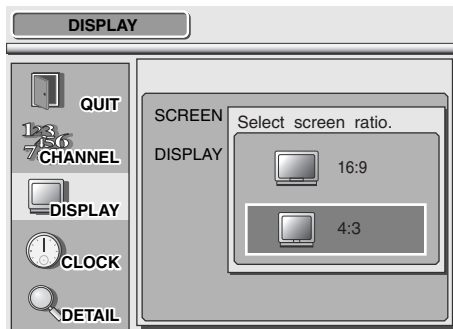
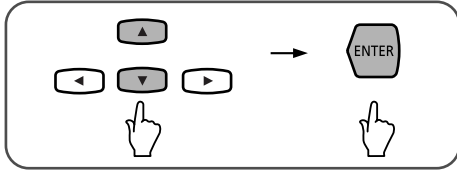

5 Press ENTER to exit SETUP menu.

NOTE:

The screen ratio should be selected to fit your TV screen.

Refer to the TV owner's manual for further information

4 Select the desired screen ratio using ▲/▼ navigation buttons, then press ENTER.

- The screen ratio will be set.

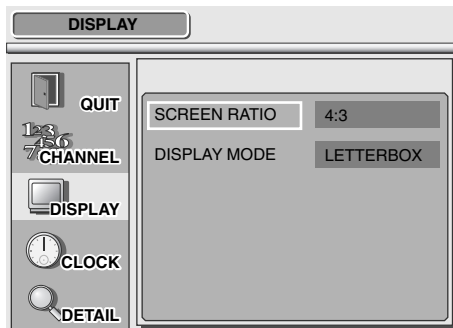
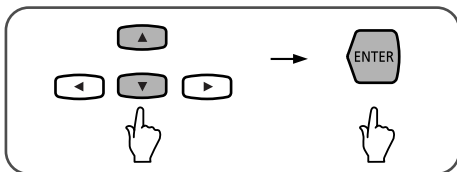

Advanced Operation

DISPLAY MODE

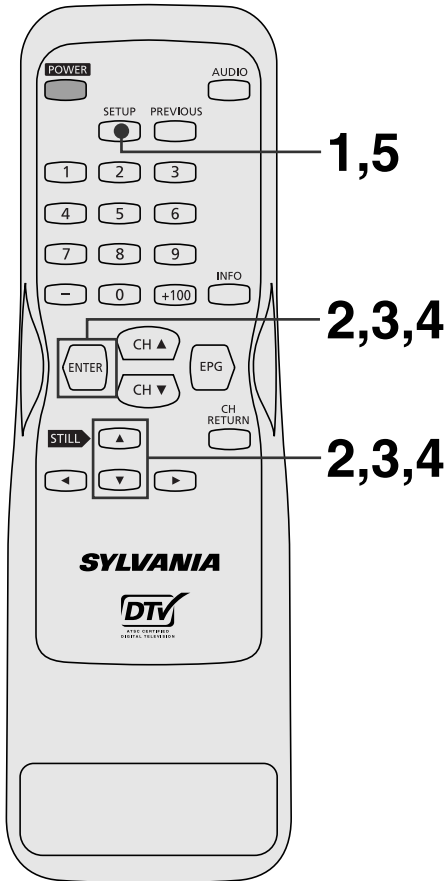

- 1 Press **SETUP** to display **SETUP** menu.

 - **SETUP** menu will appear.

Remote:

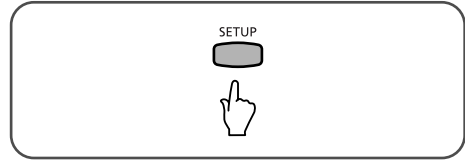

Screen:

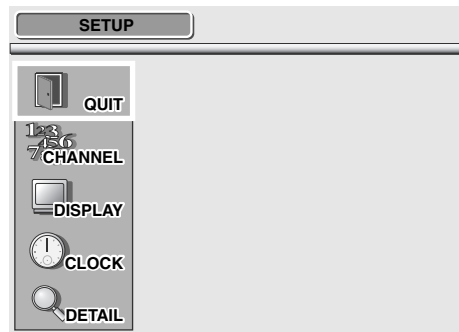

- 2 Select **DISPLAY** using **▲/▼** navigation buttons, then press **ENTER**.

 - **DISPLAY** menu will appear.

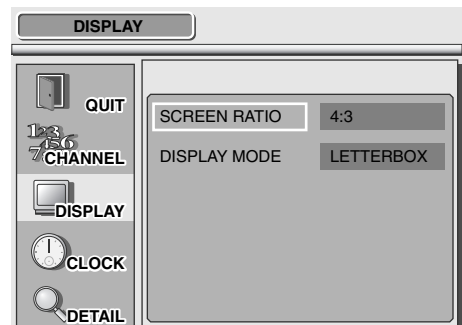
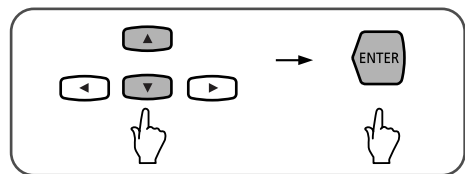

3 Select DISPLAY MODE, using ▲/▼ navigation buttons, then press ENTER.

- Display mode options will appear.

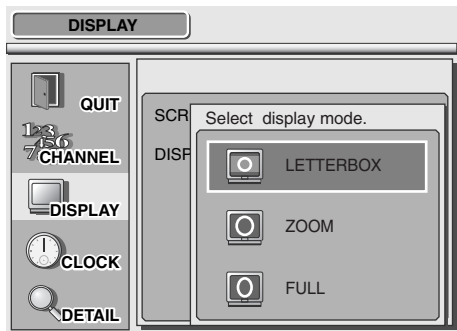
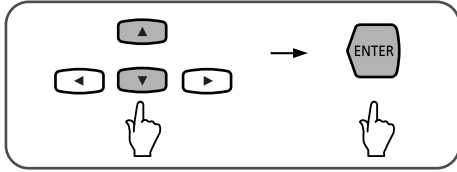

4 Select the desired display mode using ▲/▼ navigation buttons, then press ENTER.

- The display mode will be set.

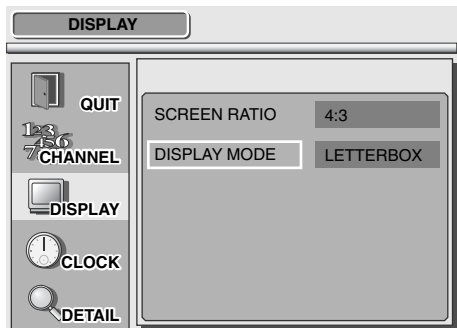
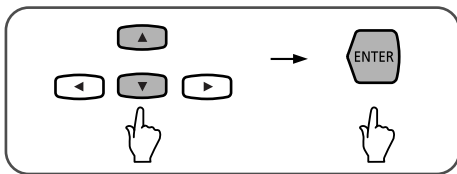

NOTE:

You can choose the display mode as you prefer. Refer to “INFORMATION on Screen Ratio and Display Mode” on page 58 for further information.

5 Press SETUP to exit SETUP menu.

CAUTION:

If the TV is left in LETTERBOX or SIDEBAR for a long period of time, the still image may cause a burn-in effect damaging the TV screen.

INFORMATION on 4:3 TV

When your 4:3 TV (capable of receiving a 1080i signal) with the screen ratio 4:3 receives a 1080i video output signal from STB, black/gray bars may appear at the top and bottom of the screen. That is because STB has been set to the screen ratio to 4:3 and the display mode SIDEBAR.

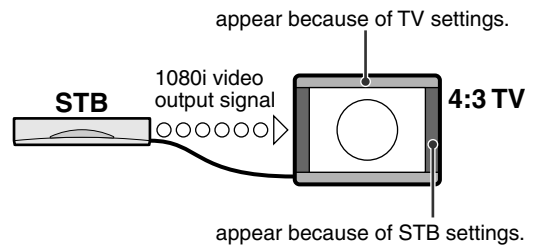

We recommend setting the STB screen ratio to 16:9, then setting the display mode as preferred, or changing the resolution selection switch on the rear panel of the STB to “480p” or “480i.”

Advanced Operation

INFORMATION on Screen Ratio and Display Mode

For standard 4:3 TVs displaying widescreen 16:9 broadcasts, your choices are:

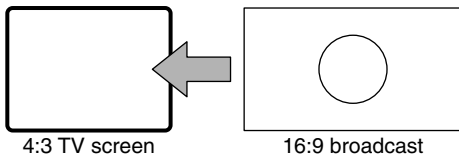

Letter Box

Displays the entire picture image while fitting the picture to the screen by applying gray bars to the top and bottom of the screen.
No information will be lost.



Zoom

Expands the picture image to fill the screen while cropping some images on the left and right. Picture information on the left and right side will be lost.



Full

Displays the entire picture image while fitting the picture to the screen by stretching the image vertically, so that it fills the screen.
No information will be lost, but there may be a slight distortion of the picture.

For widescreen 16:9 TVs displaying standard 4:3 broadcasts, your choices are:

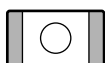
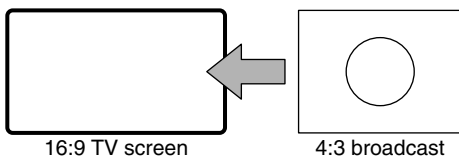

Sidebar

Displays the entire picture centering the image by applying gray bars to the left and right sides of the screen.
No information will be lost.

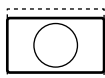

Zoom

Expands the picture image to fill the screen while cropping some images on the top and bottom. Picture information on the top and bottom will be lost.

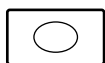

Full

Displays the entire picture image while fitting the picture to the screen by stretching the image horizontally, so that it fills the screen.
No information will be lost, but there may be a slight distortion of the picture.

Setting the clock

To get the EPG (Electronic Program Guide) and Channel banner, you need to set the CLOCK correctly.

NOTE:

The clock function is featured for displaying EPG so there may be 5 minute-time lag a day at the maximum. Therefore we recommend to set the Auto clock setting to ON to use the clock function effectively.

In the CLOCK menu, set Daylight Savings Time (DST) and TIME ZONE before setting the clock. Those settings will be influential when setting the current time.

NOTE:

Before going to MANUAL menu, set Daylight Savings Time (DST) and TIME ZONE.

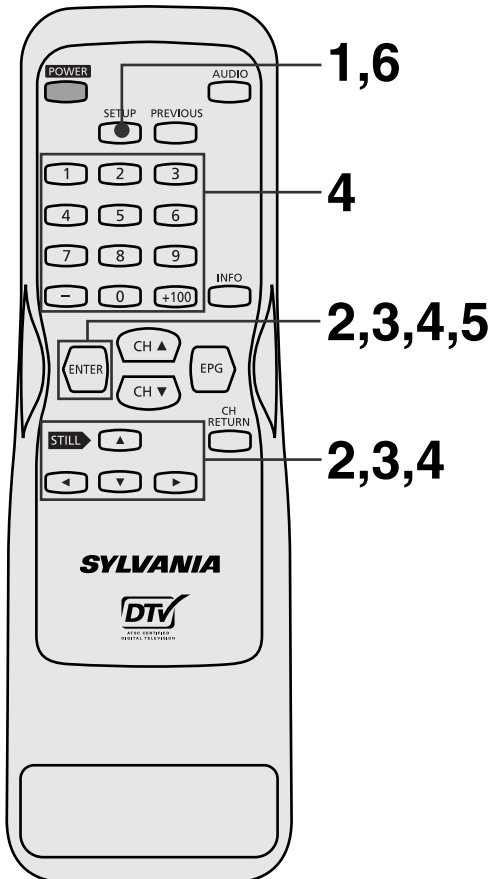

1 Press SETUP to display SETUP menu.

- SETUP menu will appear.

Remote:

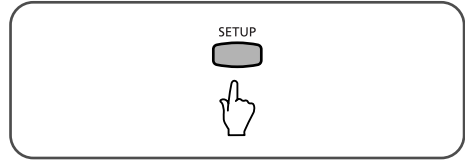

Screen:

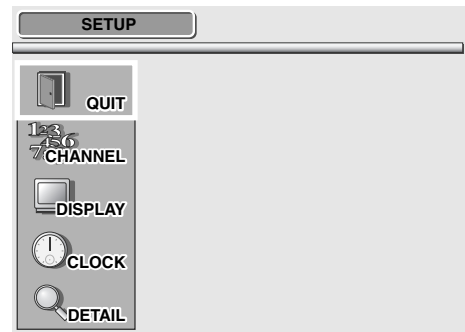

2 Select CLOCK using ▲/▼ navigation buttons, then press ENTER.

- CLOCK menu will appear.

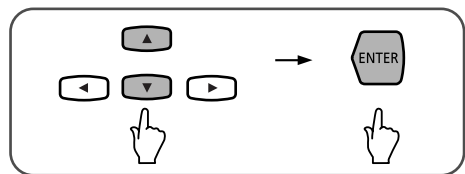

Advanced Operation

3 Select Daylight Savings Time (DST) using ▲/▼ navigation buttons, then press ENTER.

- Daylight savings time setting menu will appear.

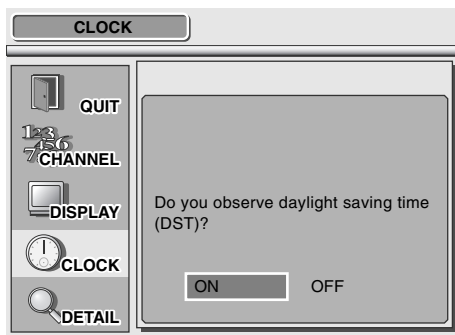
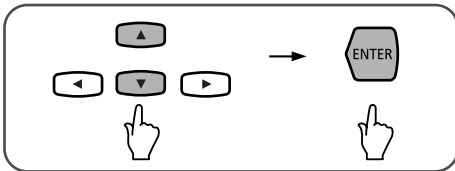

5 Select TIME ZONE using ▲/▼ navigation buttons, then press ENTER.

- TIME ZONE setting menu will appear.

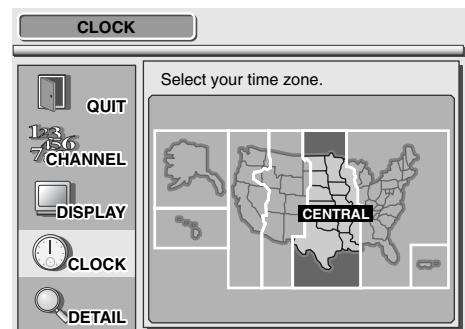
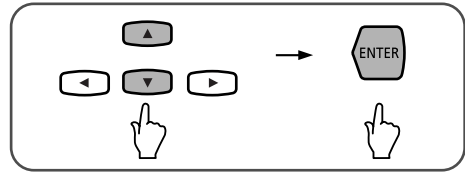

4 Select ON or OFF using ◀/▶ navigation buttons, then press ENTER.

- Daylight savings time will be set, then CLOCK menu will appear.

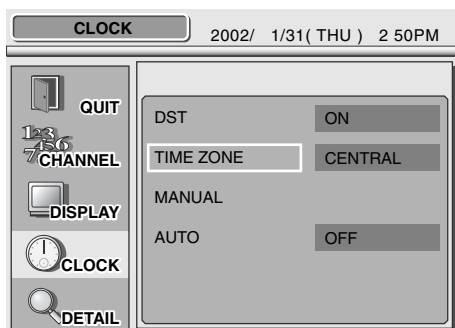
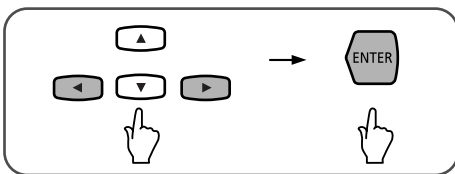

INFORMATION on Time Zones

ALASKA:



HAWAII:



PACIFIC:



MOUNTAIN:



CENTRAL:

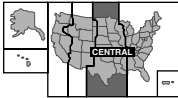

EASTERN:



ATLANTIC:

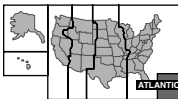

6 Select the desired time zone using ▲ / ▼ / ◀ / ▶ navigation buttons, then press ENTER.

- The TIME ZONE will be set, then CLOCK menu will appear.

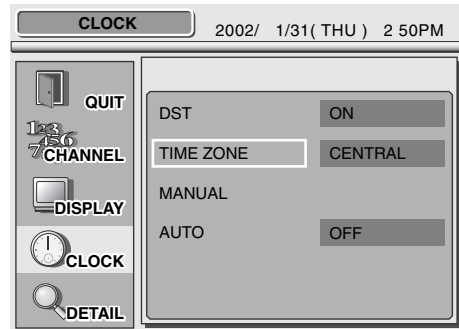
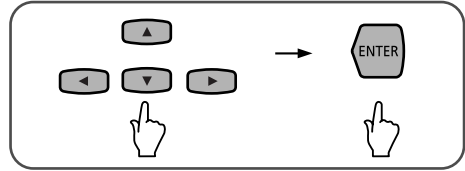

Advanced Operation

7 Select MANUAL using ▲/▼ navigation buttons, then press ENTER.

- The current time setting menu will appear.

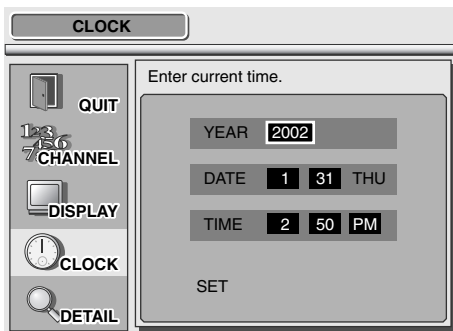
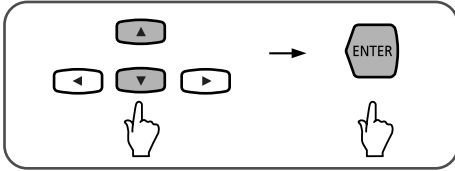

8 Enter YEAR, DATE, and TIME using ▲/▼ / ◀/▶ navigation buttons or number buttons.

- Press ENTER to set each value, then the cursor will move to the next.
- When going back and forth, press ◀/▶ navigation buttons to move the cursor.

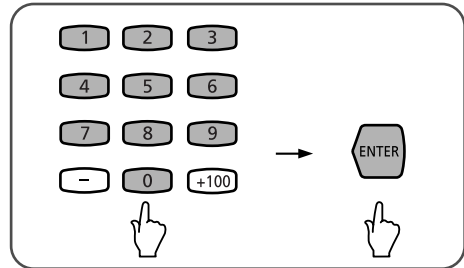

or

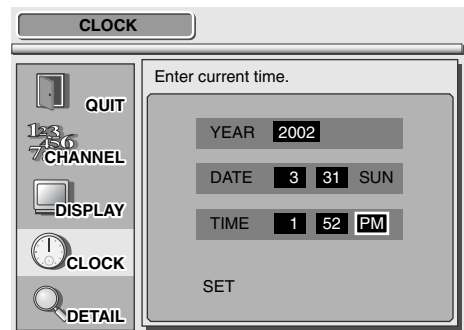
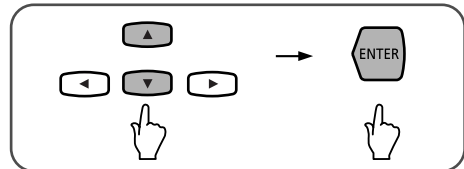

NOTE:

After all information is entered, the cursor will move to SET.

TIP:

To enter the YEAR, enter the last 2 digits of the year. The year will be entered. (e.g., Enter "03" using number buttons; 2003 will be shown.)

9 Press ENTER when the cursor is on SET.

- Your settings will be activated.

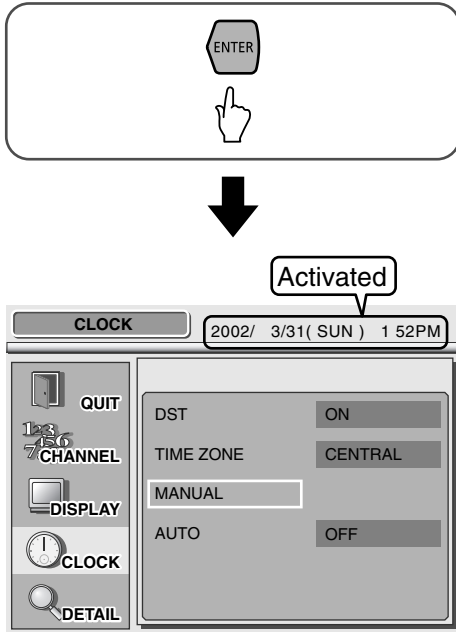

10 Press SETUP to exit SETUP menu.

Adjusting the clock automatically

STB is capable of adjusting the clock automatically using the channel clock data included in the signal from digital broadcast sources.

In this menu, STB will search for channels with clock data, then select a channel to adjust the clock. STB will then adjust the clock using the channel selected.

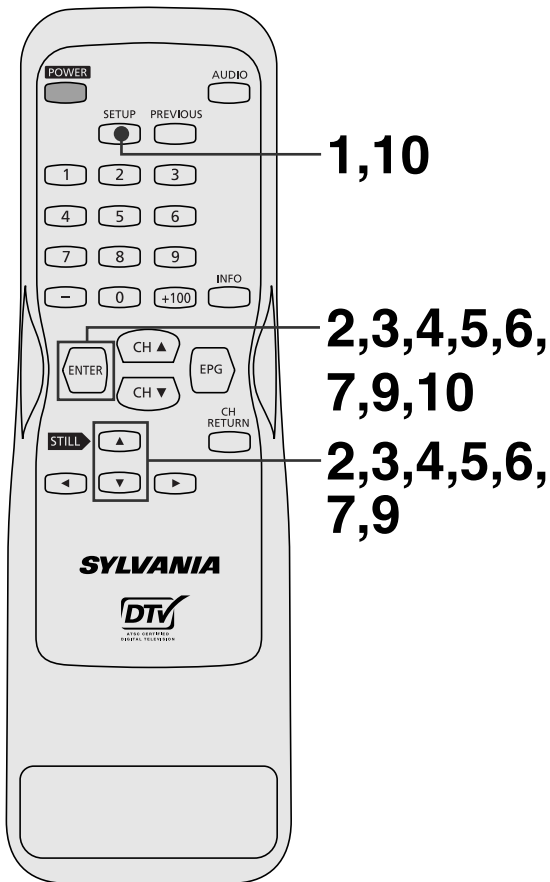

- 1 Press **SETUP** to display **SETUP** menu.

 - **SETUP** menu will appear.

Remote:

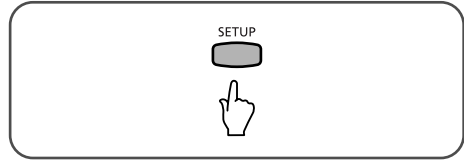

Screen:

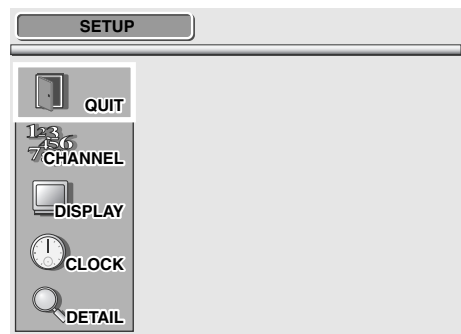

- 2 Select **CLOCK** using **▲/▼** navigation buttons, then press **ENTER**.

- **CLOCK** menu will appear.

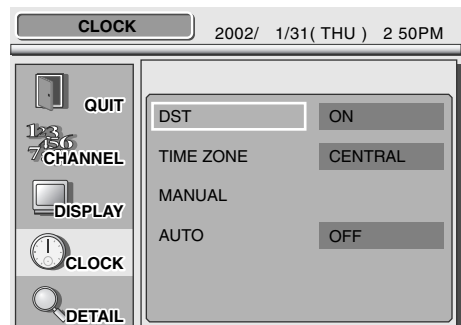
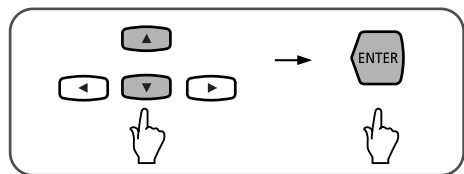

3 Select AUTO using ▲/▼ navigation buttons, then press ENTER.

- Auto clock setting menu will appear, then STB will start searching for channels with clock data.

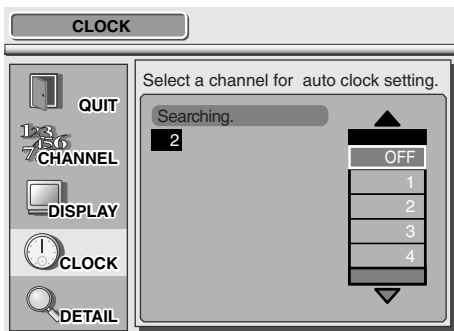
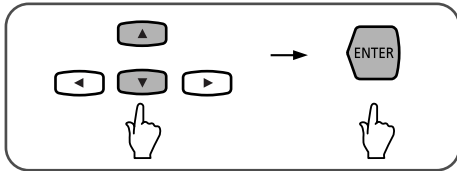

5 Select the desired channel using ▲/▼ navigation buttons, then press ENTER.

- The selected channel will be set, then the clock of STB will be activated.

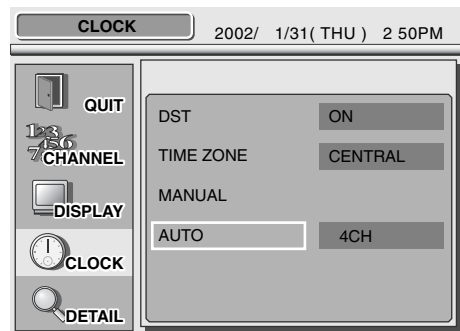
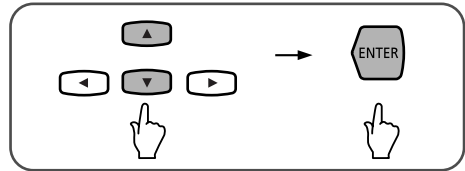

When not using the auto-clock setting:

Select OFF from the channel-map, then press ENTER.

TIP:

OFF is located at the top of the channel map. Keep pressing ▲ navigation button to search.

TIP:

You can select the desired channel being searched on the channel map by moving the cursor even when STB is in the searching mode.

4 When searching is complete, the channel numbers being searched for will become black on the channel map.

- “Channel search completed.” will be indicated.

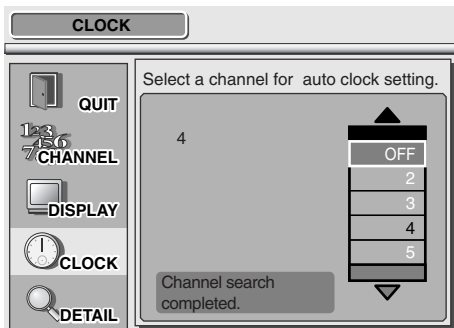

6 Press ENTER to exit SETUP menu.

Setting a new password

You will need to change the 4-digit password to protect your V-CHIP/CC setting. "0000" has been stored as the default password.

NOTE:

Once the power supply is stopped due to the power failure or the unplugging AC power cord for approx. 5 seconds, the password will go back to the default password "0000."

NOTE:

Don't forget your password. It will be needed to set the V-CHIP/CC.

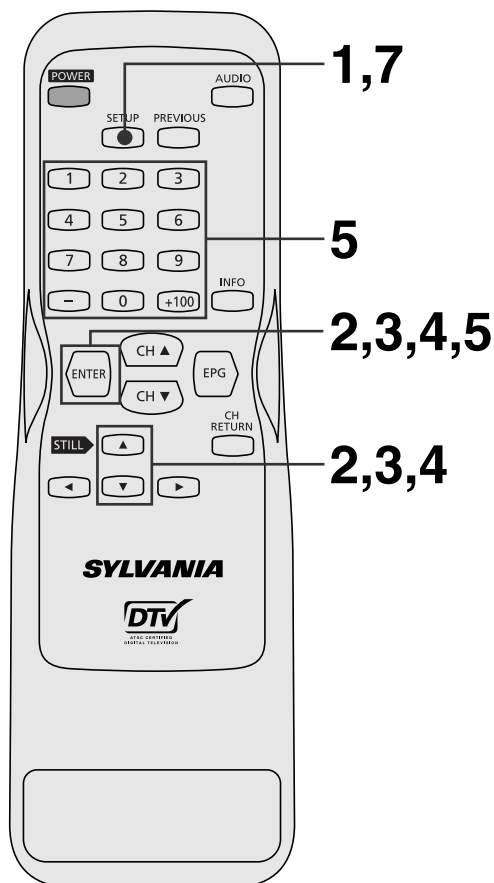

1 Press SETUP to display SETUP menu.

- SETUP menu will appear.

Remote:

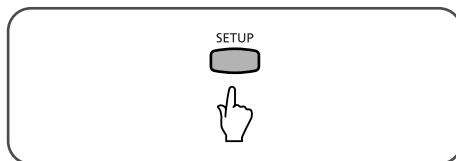

Screen:

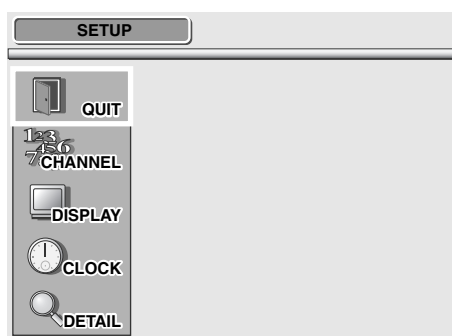

2 Select DETAIL using ▲/▼ navigation button, then press ENTER.

- DETAIL menu will appear.

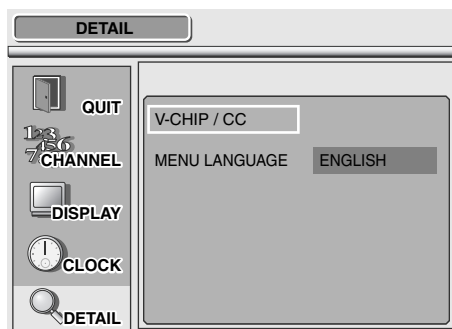
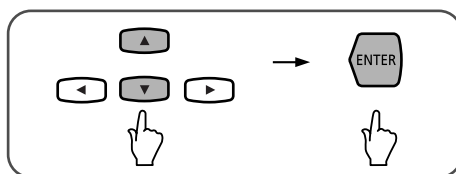

3 Select V-CHIP/CC using ▲/▼ navigation button, then press ENTER.

- V-CHIP/CC password window will appear.

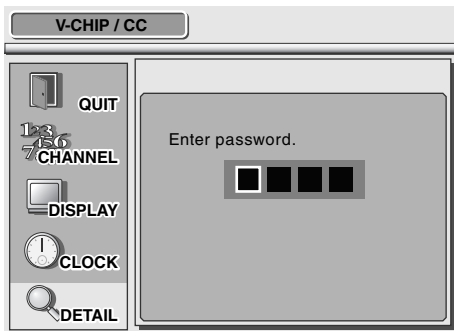
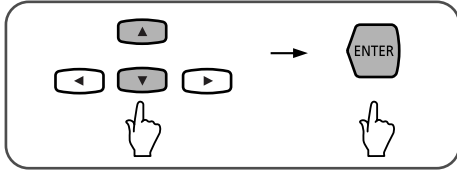

4 Enter the default password "0000."

- " * " will appear for each digit.

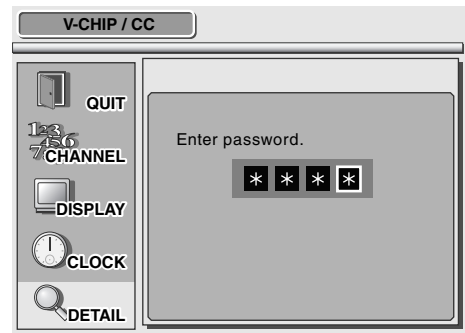
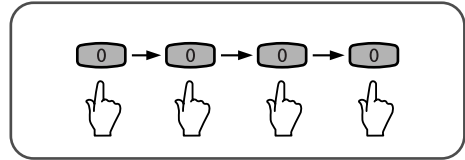

After entering the default password, V-CHIP/CC menu will appear.

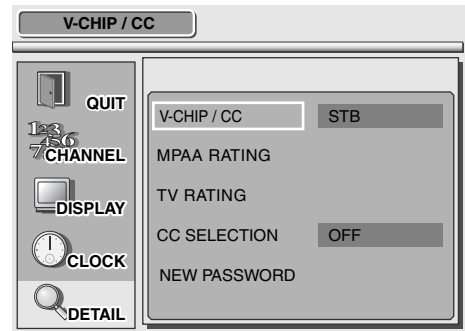

Advanced Operation

5 Select NEW PASSWORD using ▲/▼ navigation buttons, then press ENTER.

- Password setting menu will appear.

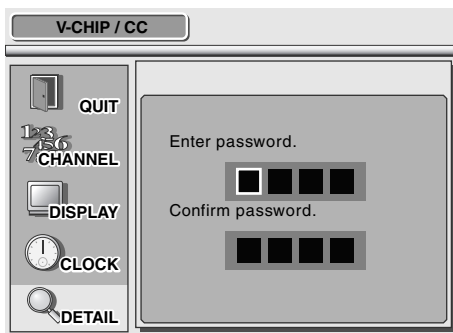
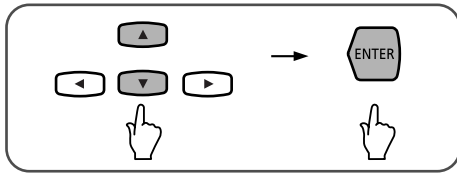

6 Enter a new 4-digit password in the upper space, then enter again in the lower space to confirm.

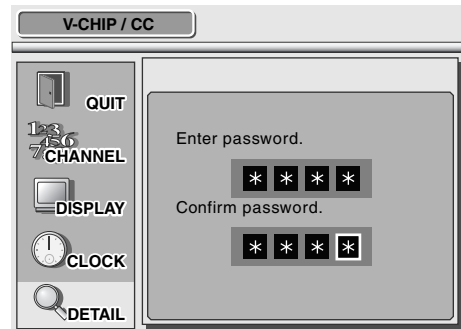
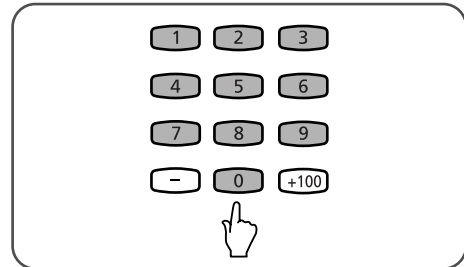

7 V-CHIP/CC menu will appear.

- Your new password is stored.

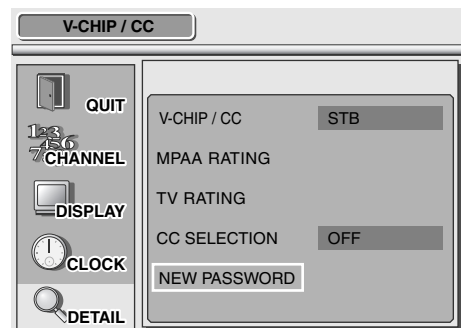

8 Press SETUP to exit SETUP menu.

Setting for V-CHIP/CC

V-CHIP/CC

In V-CHIP/CC menu, you will make some important settings for the viewing programs you select. First of all, you will need to set your 4-digit password for your V-CHIP setting. Then you can proceed with making your settings.

STB incorporates V-CHIP technology to block the viewing of movies and television programs according to their rating categories.

When V-CHIP and Closed Caption (CC) systems are built into your TV, you can use STB V-CHIP/CC settings.

In this menu, you will choose STB or TV as your standard to transmit V-CHIP/CC information. When V-CHIP/CC is set to STB, the settings will be valid. Please set the rating level on the STB. When set to TV, the settings are not valid. Please set the rating level on the TV.

NOTE:

STB has been selected as the default before purchase.

INFORMATION on V-CHIP

V-CHIP is built into a TV or other video devices to work in conjunction with the TV Parental Guidelines. It electronically reads television-programming ratings and allows parents to block programs they believe are unsuitable for their children.

There are two rating categories in use, TV ratings for TV programs and MPAA ratings for theatrical movies being broadcast.

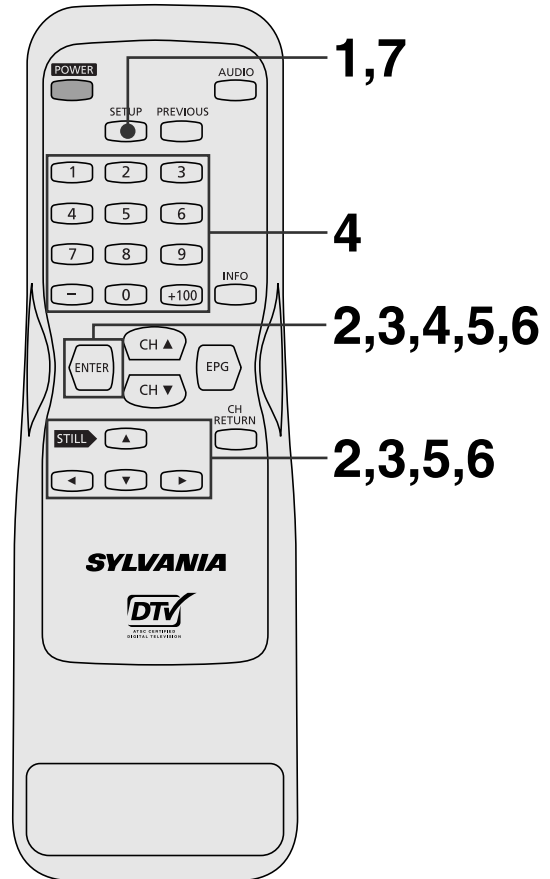

Advanced Operation

1 Press SETUP to display SETUP menu.

- SETUP menu will appear.

Remote:

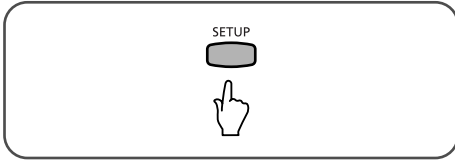

Screen:

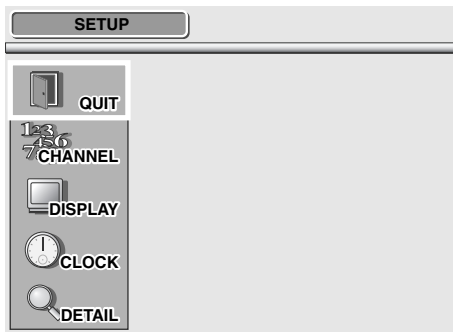

3 Select V-CHIP/CC using ▲/▼ navigation buttons, then press ENTER.

- V-CHIP/CC password window will appear.

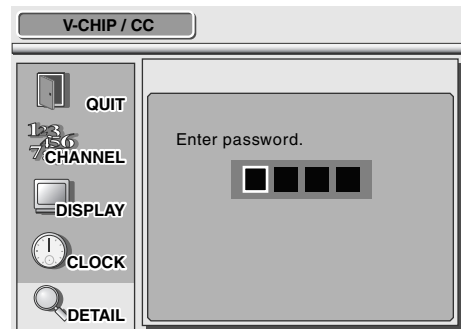
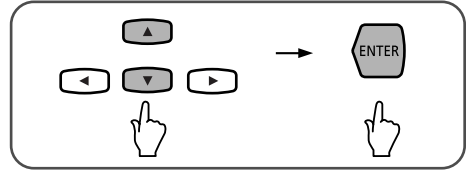

2 Select DETAIL using ▲/▼ navigation buttons, then press ENTER.

- DETAIL menu will appear.

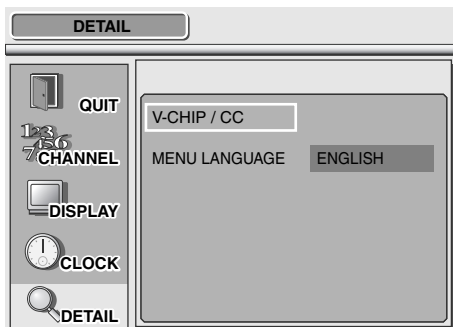
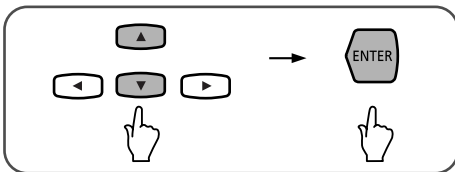

4 Enter your 4-digit password.

- “ * ” will appear for each digit.

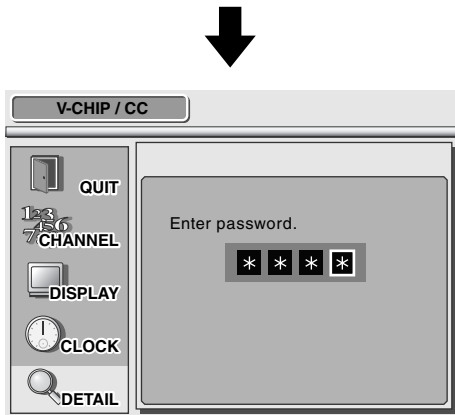
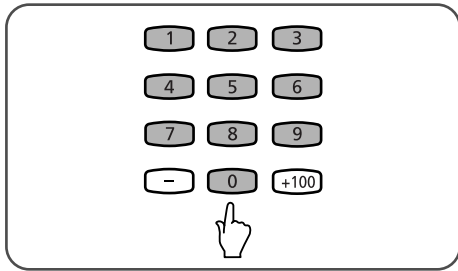

After the correct password is entered, V-CHIP/CC menu will appear.

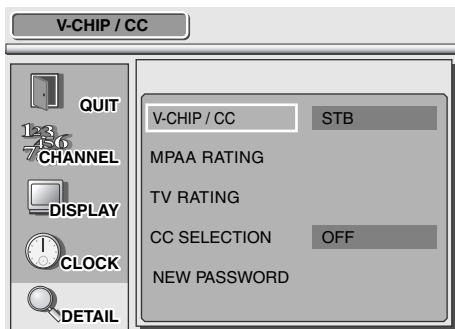

5 Select V-CHIP/CC using ▲ / ▼ navigation buttons, then press ENTER.

- V-CHIP/CC setting menu will appear.

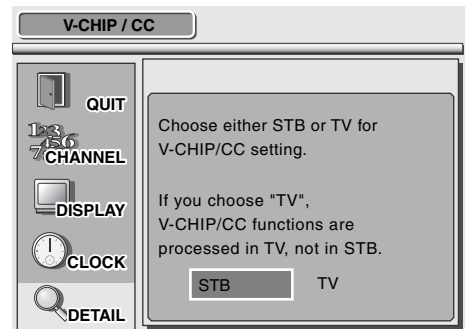
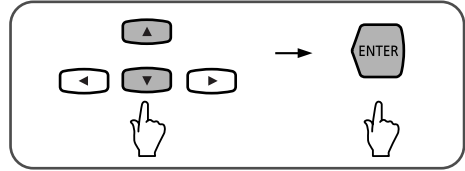

NOTE:

To set V-CHIP/CC settings, choose STB.

When choosing “STB” controls V-CHIP Ratings:

- The STB settings of V-CHIP/CC will become effective.
- You will need to make the settings of V-CHIP/CC with STB.
- You can watch the program according to the STB settings of V-CHIP/CC.

When choosing “TV” controls V-CHIP Ratings:

- The STB settings of V-CHIP/CC will not become effective.
- You can watch the program according to the TV settings of V-CHIP/CC.
- You will need to make the settings of V-CHIP/CC with the TV.

NOTE:

For the TV settings, refer to the TV owner’s manual.

Advanced Operation

- 6 Select STB or TV using ◀/▶ navigation buttons, then press ENTER.

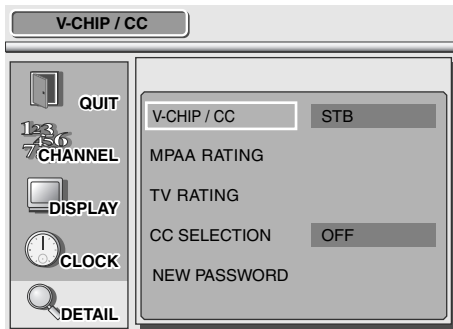
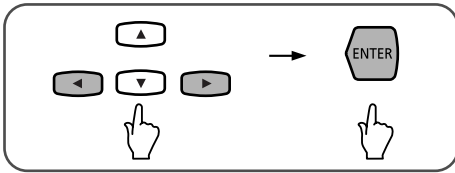

- 7 Press SETUP to exit SETUP menu.

Setting MPAA rating

MPAA RATING

The MPAA (Motion Picture Association of America) uses the standard movie ratings.

Age Label	Description
NR	Not Rated by MPAA
G	General Audience
PG	Parental Guidance Suggested. Some material may not be suitable for children.
PG-13	Parents Strongly Cautioned. Some material may be inappropriate for children under 13.
R	Restricted. Under 17 requires accompanying parent or guardian.
NC-17	No one 17 and under admitted. Some material is intended to be viewed by adults only.
X	No one 17 and under admitted. Some material is explicitly sexual and is intended to be viewed by adults only.

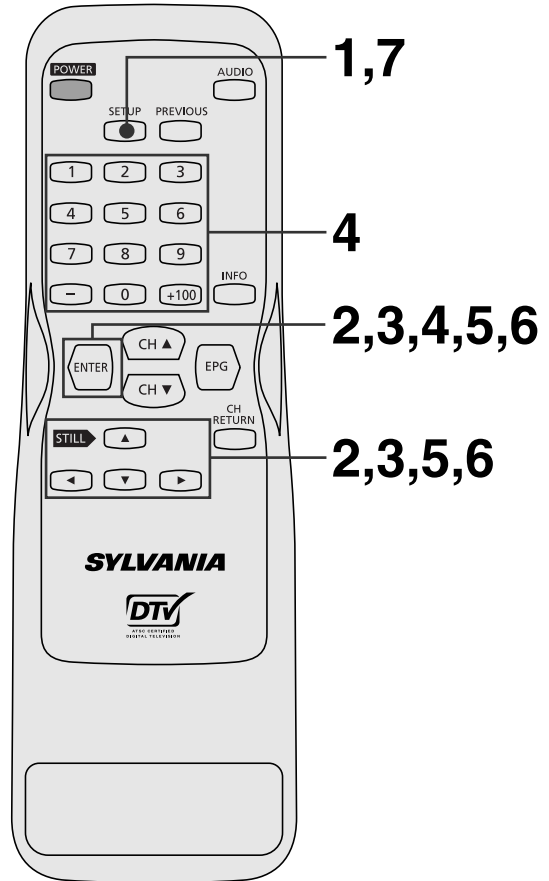

Advanced Operation

1 Press SETUP to display SETUP menu.

- SETUP menu will appear.

Remote:

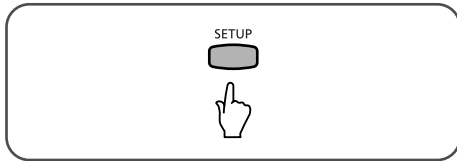

Screen:

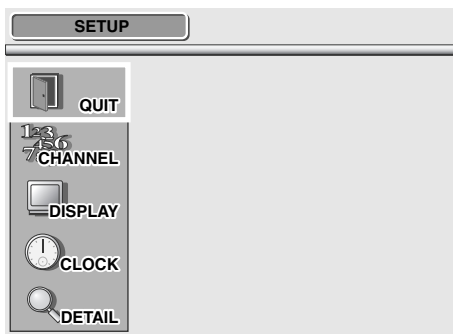

3 Select V-CHIP/CC using ▲/▼ navigation buttons, then press ENTER.

- V-CHIP/CC password window will appear.

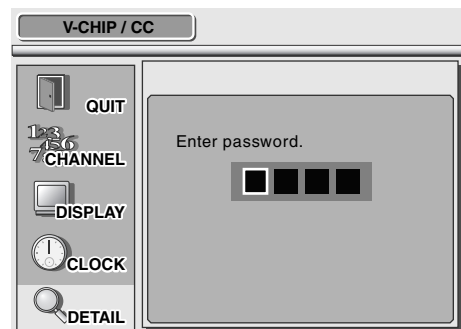
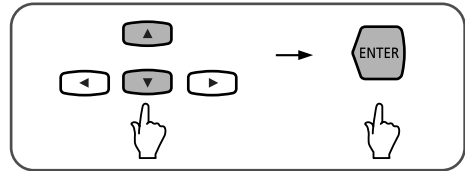

2 Select DETAIL using ▲/▼ navigation buttons, then press ENTER.

- DETAIL menu will appear.

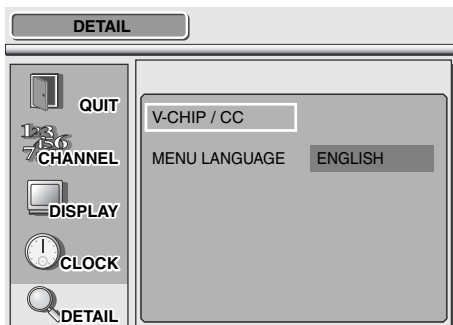
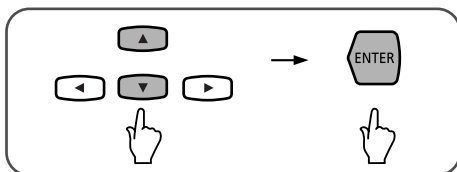

4 Enter your 4-digit password.

- “ * ” will appear for each digit.

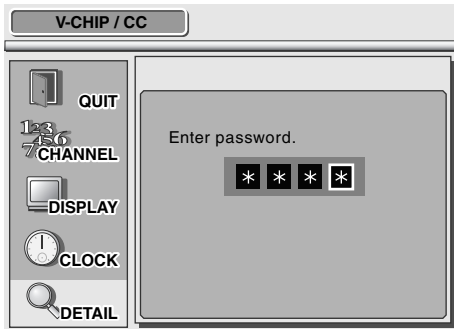
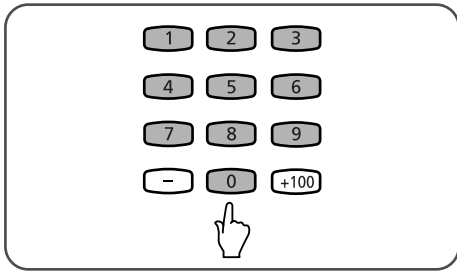

5 Select MPAA RATING using ▲ / ▼ navigation buttons, then press ENTER.

- MPAA rating setting menu will appear.

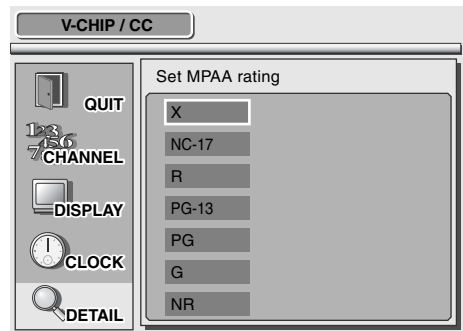
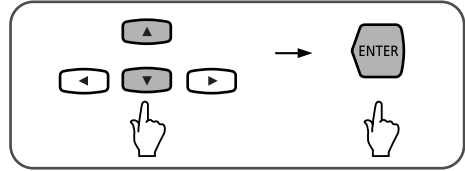

After entering the correct password, V-CHIP/CC menu will appear.

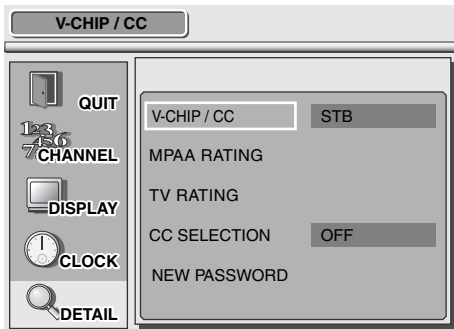

Advanced Operation

6 Select PG-13 using ▲/▼ navigation buttons, then press ENTER.

7 Press SETUP to exit SETUP menu.

E.g., when you want to block all PG-13 movies:

- Lock indicators will be added to programs rated PG-13 and above.

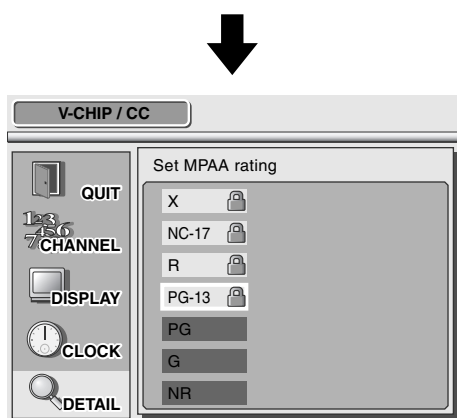
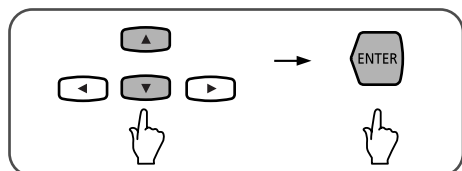

NOTE:

All movie programs rated PG-13 and above will be blocked. When STB receives broadcasts of those programs, STB will block both video and audio signals to output, and RESTRICTED PROGRAM will appear on the screen.

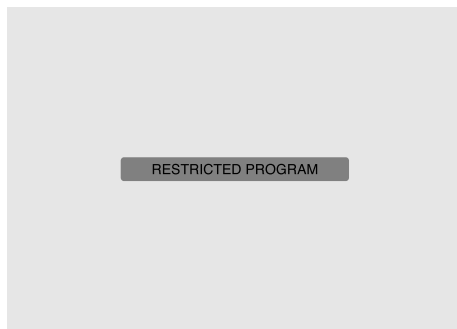

TIP:

Pressing ENTER will unblock a previously blocked rating so that it can be selected.

Setting TV rating

TV RATING

(TV Parental Guidelines)

TV rating allows parents to block out programs they don't want their children to see.

TV rating consists of the age labels and the content labels.

The following are the descriptions for each label:

Age Label	Description
TV-MA	Mature Audience Only : Specifically designed to be viewed by adults and therefore may be unsuitable for children under 17. Possible content label : L, S, V
TV-14	Parents Strongly Cautioned: Contains some material that many parents would find unsuitable for children under 14 years of age. Possible content label : D, L, S, V
TV-PG	Parental Guidance Suggested : Contains material that parents may find suitable for younger children. Possible content label : D, L, S, V
TV-G	General Audience : Most parents would find this program appropriate for all ages.
TV-Y7	Directed to Older Children : Designed for children age 7 and above. Possible content label : FV
TV-Y	All Children : Designed to be appropriate for all children.

Content Label	Description
D	suggestive dialogue
L	coarse language
S	sexual situations
V	violence
FV	fantasy violence

NOTE:

When you block a particular rating or content label, all categories above that will also be blocked.

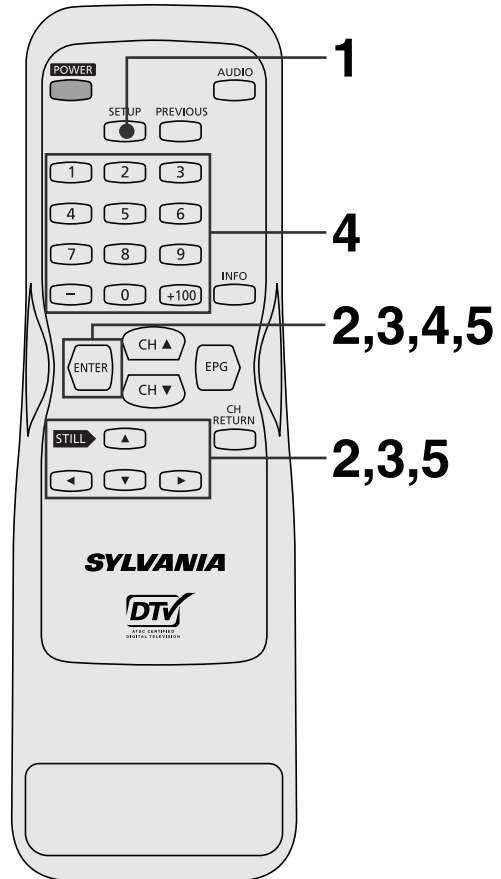

Advanced Operation

1 Press SETUP to display SETUP menu.

- SETUP menu will appear.

Remote:

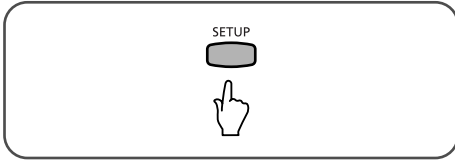

Screen:

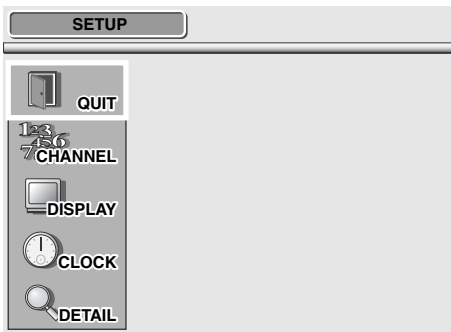

3 Select V-CHIP/CC using ▲/▼ navigation buttons, then press ENTER.

- V-CHIP/CC password window will appear.

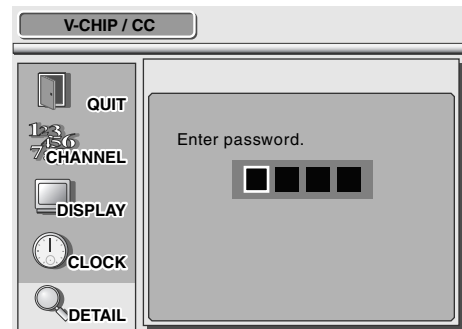
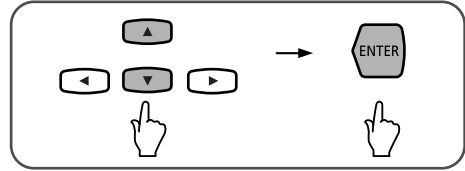

2 Select DETAIL using ▲/▼ navigation buttons, then press ENTER.

- DETAIL menu will appear.

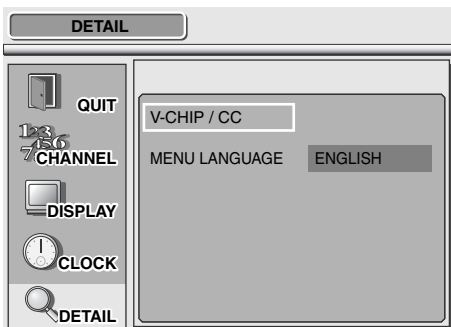
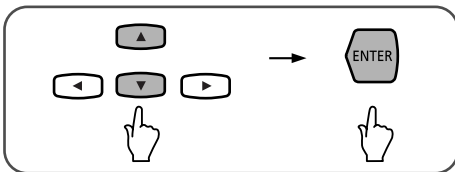

4 Enter your 4-digit password.

- “ * ” will appear for each digit.

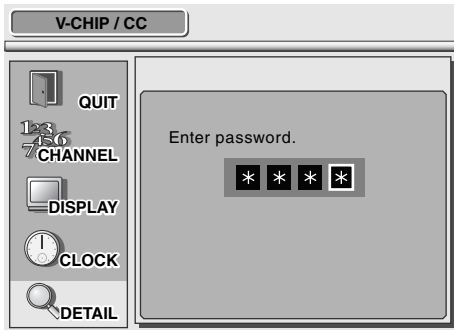
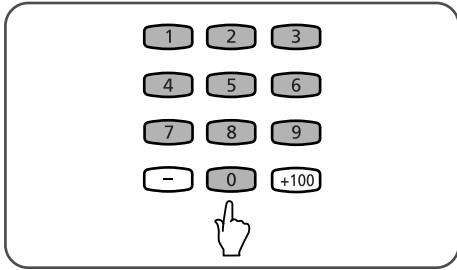

5 Select TV RATING using ▲/▼ navigation buttons, then press ENTER.

- TV rating setting menu will appear.

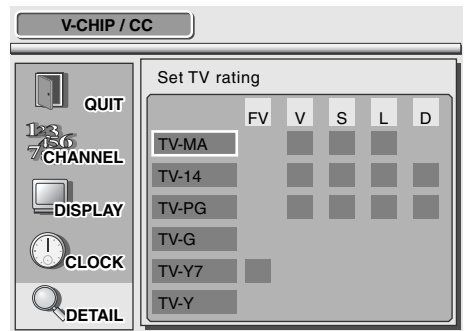
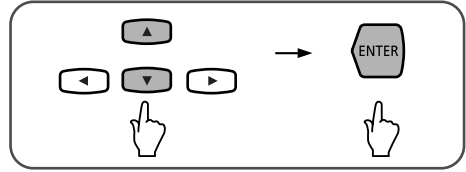

After the correct password is entered, V-CHIP/CC menu will appear.

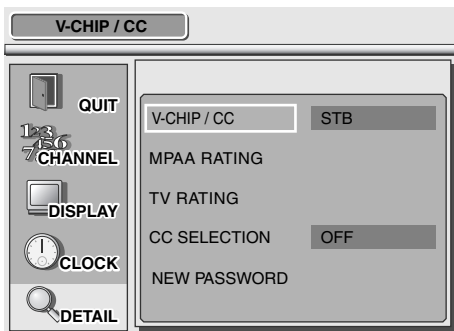

INFORMATION on TV ratings

Advanced Operation

To set age-based ratings:

E.g., when you want to block all TV-14 programs

1. Select TV-14 using ▲ / ▼ navigation buttons, then press ENTER.
- Lock indicators will be added to all TV-14 and higher categories.

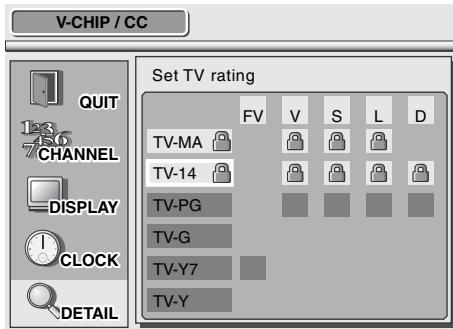
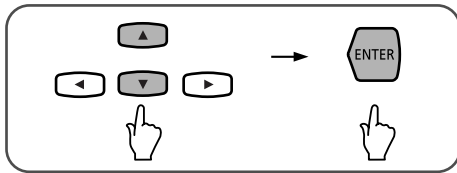

NOTE:

All TV-14 and higher programs will be blocked, along with all the labels of their possible contents. When STB receives broadcasts of those programs, STB will block both video and audio signals to output, and RESTRICTED PROGRAM will appear on the screen.

2. Press SETUP to exit SETUP menu.

To set content-based ratings:

E.g., when you want to block only TV-14 programs that contain higher levels of violence

1. Select TV-14-V using ▲ / ▼ / ◀ / ▶ navigation buttons, then press ENTER.
- Lock indicators will be added to TV-14-V and above.

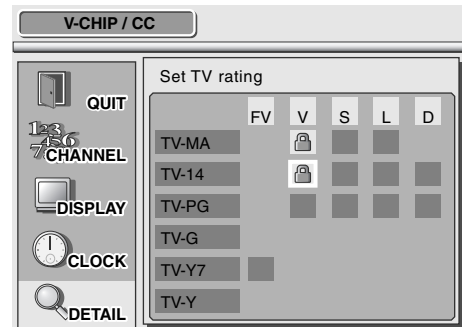
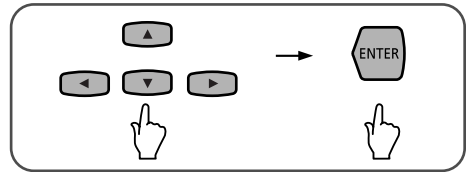

NOTE:

All TV-14-V and higher programs will be blocked. When STB receives broadcasts of those programs, STB will block both video and audio signals to output, and RESTRICTED PROGRAM will appear on the screen.

2. Press SETUP to exit SETUP menu.

Selecting CC options

CC SELECTION

Closed Caption (CC) provides you with on-screen text versions of the audio content for the program being broadcast.

In this menu, you are allowed to turn Closed Caption signal On or Off, to set a language for the closed caption and to choose a format for the closed caption.

NOTE:

OFF has been selected as the default before purchase.

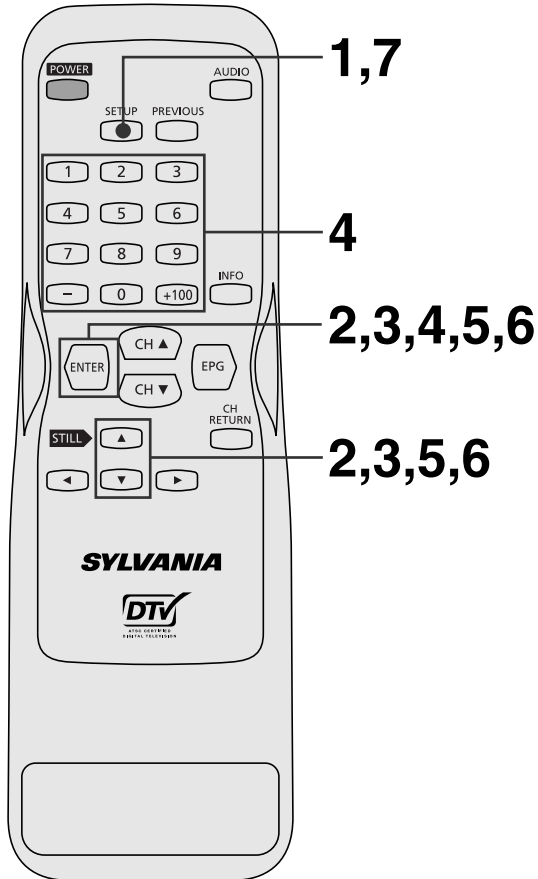

1 Press SETUP to display SETUP menu.

- SETUP menu will appear.

Remote:

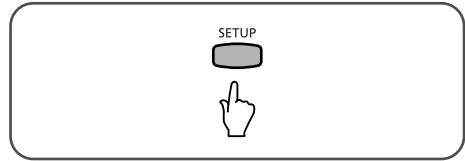

Screen:

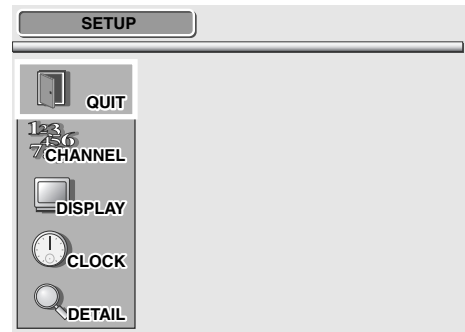

2 Select DETAIL using ▲/▼ navigation buttons, then press ENTER.

- DETAIL menu will appear.

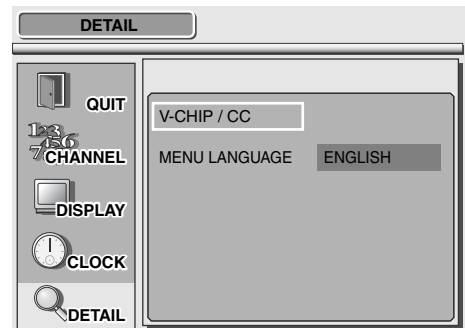
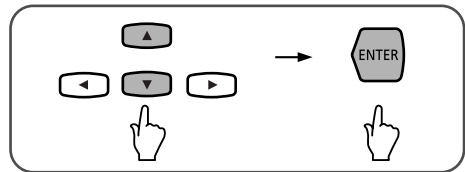

Advanced Operation

3 Select V-CHIP/CC using ▲/▼ navigation buttons, then press ENTER.

- V-CHIP/CC password window will appear.

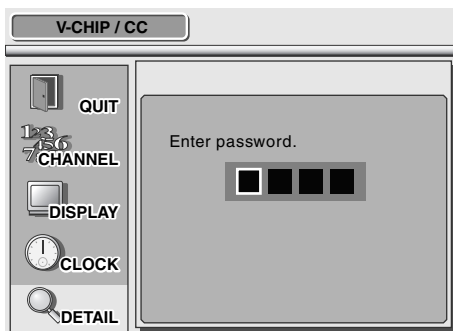
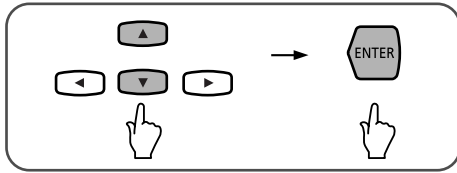

4 Enter your 4-digit password.

- “ * ” will appear for each digit.

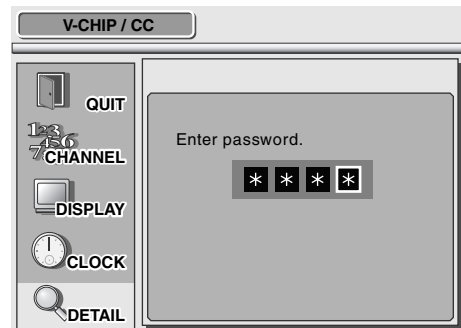
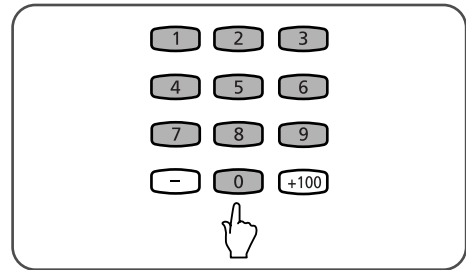

After the correct password is entered, V-CHIP/CC menu will appear.

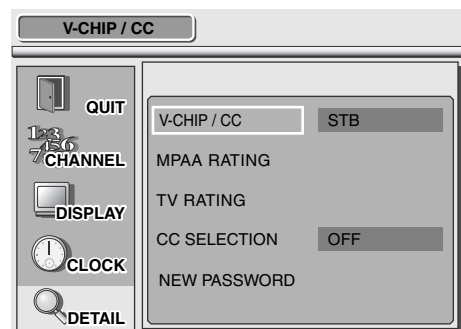

5 Select CC SELECTION using ▲/▼ navigation buttons, then press ENTER.

- CC options menu will appear.

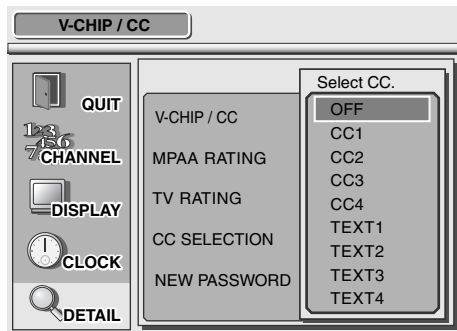
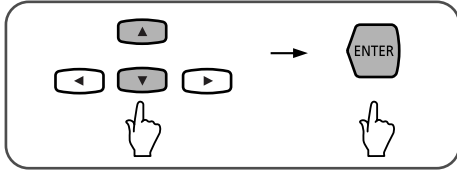

7 Press SETUP to exit SETUP menu.

INFORMATION on CC options

OFF:

Use when Closed Caption is not desired.

CC1 and TEXT1:

are the primary caption and text services. The captioning or text is displayed in the same language as the program's dialog. (up to 4 lines of script on the screen, where it does not obstruct relevant parts of the picture)

CC3 and TEXT3:

serve as the preferred data channels. The captioning or text is often a secondary language translation, simplified English, or displayed at a slower rate.

CC2, CC4, TEXT2 and TEXT4:

are rarely available and broadcasters use them only in special conditions, such as when CC1 and CC3 are not available, or TEXT1 and TEXT3 are not available.

6 Select the desired CC option using ▲/▼ navigation buttons, then press ENTER.

- The selected CC option will be set.

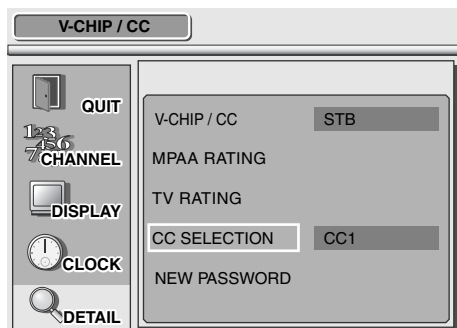
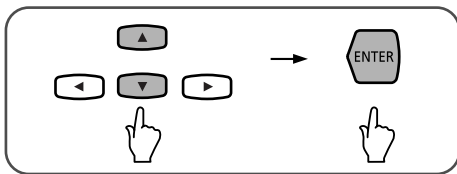

Choosing the screen language

MENU LANGUAGE

English, French, and Spanish are available for the screen menu. You can choose the language you prefer.

NOTE:

ENGLISH has been selected as the default before purchase.

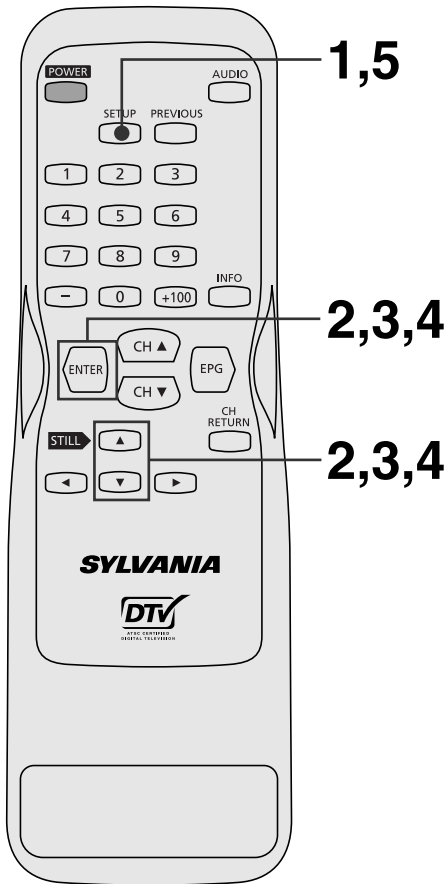

- 1 Press **SETUP** to display **SETUP** menu.

 - **SETUP** menu will appear.

Remote:

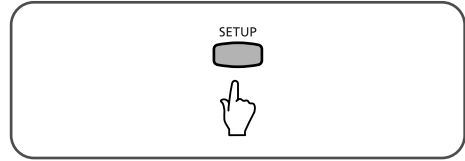

Screen:

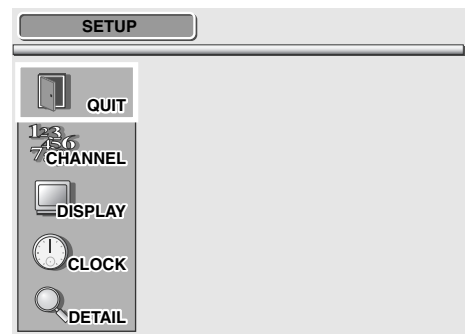

- 2 Select **DETAIL** using **▲/▼** navigation buttons, then press **ENTER**.

 - **DETAIL** menu will appear.

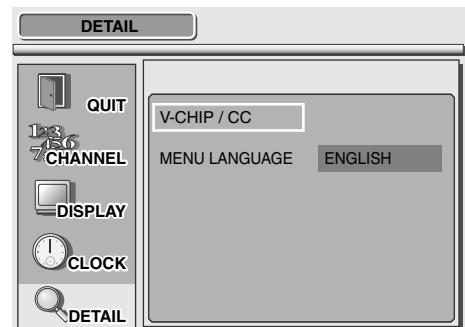
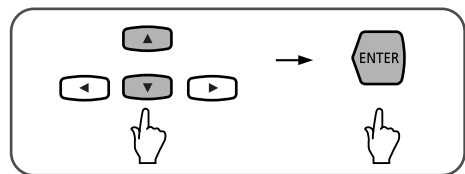

3 Select MENU LANGUAGE using ▲/▼ navigation buttons, then press ENTER.

- Language menu will appear.

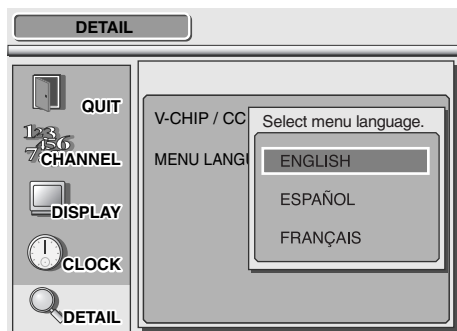
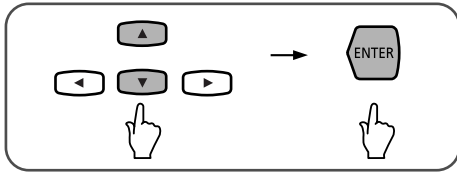

4 Select the desired language using ▲/▼ navigation buttons (E.g., select French), then press ENTER.

- The selected language will be set, and the selected language will be indicated on screen.

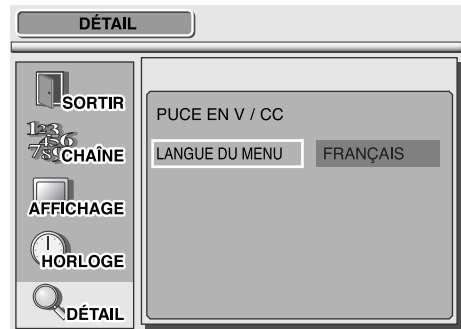
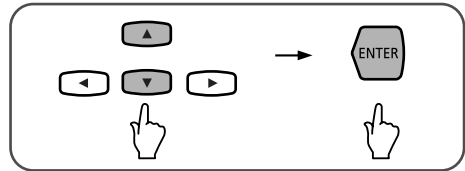

5 Press SETUP to exit SETUP menu.

Troubleshooting

Before requesting service for this unit, check the table below for a possible cause of the problem you are experiencing. Some simple checks or a minor adjustment on your part may eliminate the problem and restore proper operation.

Symptom	Remedy
No power	<ul style="list-style-type: none"> • Make sure that the AC power cord is securely plugged into the power outlet. • Make sure that STB is turned on.
The STB is not responding to the remote control unit	<ul style="list-style-type: none"> • Make sure to point the remote control unit at the remote control sensor. • You may be too far from STB. Try moving closer. • Remove any obstacles between the remote control and the remote control sensor. • Make sure that the batteries are installed in the correct direction (+ and -). • The batteries may be depleted. Replace them with new ones. • Before using the remote control unit to operate, press buttons on the front panel of STB instead.
No picture	<ul style="list-style-type: none"> • Make sure that the video cable is correctly connected. • Make sure that video devices (TV or monitor) are turned on. • Make sure that video devices (TV or monitor) are correctly set to STB video output channel. Refer to the TV owner's manual for further information. • Check the video cable. Either an S-video cable or a standard video cable is required. Do not connect them at the same time. • Check the antenna and the antenna cable. There may be damage or interfering sources.
Picture is not clear (when receiving analog signals)	<ul style="list-style-type: none"> • Check the antenna and the antenna cable. There may be damage or interfering sources.
"Snowy" picture (when receiving analog signals)	<ul style="list-style-type: none"> • Check the antenna outside. The antenna may be swaying because of the wind.
Striped picture or black and white picture (when receiving analog signals)	<ul style="list-style-type: none"> • There may be interfering sources.
Blocked noise on picture (when receiving digital signals)	<ul style="list-style-type: none"> • There may be interfering sources.
No EPG or the provided information is wrong	<ul style="list-style-type: none"> • Make sure that the clock had been correctly set. In CLOCK in SETUP menu, you need to set correctly DST, TIME ZONE and MANUAL.

Symptom	Remedy
No sound	<ul style="list-style-type: none"> • Make sure that the audio cable is correctly connected. • Make sure that audio devices (stereo, TV, decoder) are turned on. • Make sure that audio devices (stereo, decoder) are correctly set to STB audio output channel. • Check the audio cable. Either a standard audio cable or a coaxial digital audio cable is required. Do not connect them at the same time. • When TV has only one audio input jack, use a standard audio cable (white) to connect the audio output jack (white) on STB to the audio input jack on the TV. The standard audio cable (red) and the audio output jack (red) are not required.
Audio problems when using coaxial digital audio cable	<ul style="list-style-type: none"> • When receiving analog signals, coaxial digital audio does not produce digital audio. Only when receiving digital signals, does coaxial digital audio produce digital audio. • When pressing AUDIO, STEREO and MONAURAL will repeat in sequence. However, this will not affect the channels through the digital audio out jack.
No reception of digital signals	<ul style="list-style-type: none"> • Make sure that AUTOSCAN in SETUP WIZARD or SETUP menu has been completed. It will be required when you setup STB for the first time or when STB is moved to a location where other channels are broadcast. • The selected channel does not exist at that time. There are not always sub-channels being broadcast. • When AUTOSCAN is interrupted and not completed, some channels will not be received. Make sure to complete AUTOSCAN in SETUP menu.
The entered channel number changes automatically	<ul style="list-style-type: none"> • Many digital channels have alternate channel numbers. STB changes the numbers automatically to the ones signifying the broadcasting stations. These are the numbers used for analog broadcasts.
No reception of channels with weak signal (AUTOSCAN)	<ul style="list-style-type: none"> • Some channels are not received with AUTOSCAN in SETUP menu. However, when you are sure they exist, find alternate channel numbers for them (described above), then add the channel numbers with ADD in SETUP menu. You may get the information on the web site of the broadcasting stations.
When you forget the password for V-CHIP	<ul style="list-style-type: none"> • Unplug the AC power cord and wait for approx. 5 seconds, then enter the default number "0000."
Closed captioning display (TEXT mode) does not go off even after changing channels through STB.	<ul style="list-style-type: none"> • Change the TV setting to the other mode except VIDEO mode. • Change channels through the TV.

Specifications

Product

STB for ATSC/NTSC

Connecting Jacks

ANT IN

F connector (75 ohm)

Video Output (component)

3-pin jack (Y, Pb, Pr)

S-Video Output

Mini DIN 4-pin jack (75 ohm)

Video Output

1-pin jack, 1Vpp

Analog Audio Output

2-pin jack (L, R)

450 mVrms (100k ohm)

Digital Audio Output

1-pin jack (Dolby Digital)

Power Source

120 VAC+/-10 %, 60 Hz+/-0.5 %

Power Consumption

25 W (Power on), Less than 1 W (Power off)

ENERGY STAR adopted.

Operating Condition

41 F° (5 C°) - 104 F° (40 C°)

Dimensions (W x H x D)

14-3/16"(W) x 2-15/16"(H) x 13(D)

(360 mm x 75 mm x 330 mm)

Weight

6.36 lbs. (2.89 Kg)

Designs and Specifications are Subject to change without notice.

Glossary and Acronyms

ATSC:

ATSC (Advanced Television Systems Committee) is the group that has been working to establish the standards for digital television broadcasting and digital television equipment - including both SDTV and HDTV.

Audio map:

Audio format and language outputs from a broadcasting station are stored in an audio-map. For example, when three language are available, the sequence below will repeat and the desired audio format and language can be set.

Audio output jack:

Audio output jack is located on the rear panel of STB and send audio signal to other device connected by a audio cable.

Autoscan:

AUTOSCAN is capable of receiving available channels, both analog and digital, and storing those channels in a channel map.

Channels once stored in a channel map can be selected using CH ▲ / ▼ buttons.

Component video output jack (Y/ Pb/ Pr):

Component video output jack is located on the rear panel of STB and provide superior picture to other connections. And you can select the video resolution by using the resolution selection switch.

Digital audio (coaxial) output jack:

Digital audio (coaxial) output jack send digital audio data to audio devices equipped with a digital audio (coaxial) input jack.

Dolby® Digital:

Dolby® Digital (when available) provides 6 independent soundtrack channels through the coaxial output jack.

STB has a Dolby Digital output (labeled DIGITAL AUDIO (COAXIAL)) that can be connected to an external Digital Audio receiver/ decoder equipped with a coaxial input. With additional equipment you can enjoy more dynamic and realistic sound at home.

DST:

Daylight Savings Time

Electronic Program Guide (EPG):

EPG is the electronic equivalent of a printed television program guide.

You can view a list of programs scheduled for from the next few hours up to the next seven days.

HD:

High Definition

HDTV:

High Definition Television:

HDTV signal formats are 1080i (interlaced scan) and 720p (progressive scan). HDTV provides the highest resolution picture and audio in either stereo or 5.1 channel surround sound.

MPAA:

Motion Picture Association of America

A guild governing rating assignments to movies.

NTSC:

NTSC (National Television Standards Committee) refers to the group that first established the standards used for conventional analog television broadcasting and TV equipment.

Password:

A stored 4-digit number that you must provide in order to make settings for V-CHIP/CC.

SD:

Standard Definition

SDTV:

Standard Definition Television:

SDTV signal formats are 480p and 480i. SDTV provides lower resolution, yet presents a very sharp, clear picture. Lower resolution allows broadcasters to transmit multiple programs per channel.

Sub-Channel:

Because of the compression of audio and video signals, each digital channel is able to carry different programs on sub-channels through a single channel. You can select them by simply pressing CH ▲ / ▼ buttons on your remote control when available.

S-Video output jack:

S-Video output jack is located on the rear panel of STB and provides a high-quality picture to video devices equipped with an S-Video input jacks.

Video output jack:

Video output jack is located on the rear panel of STB and send video signal to other device connected by a video cable.

Ubicación de los controles

PANEL FRONTAL

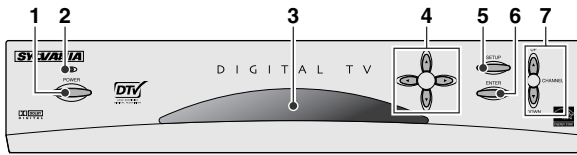

PANEL TRASERO

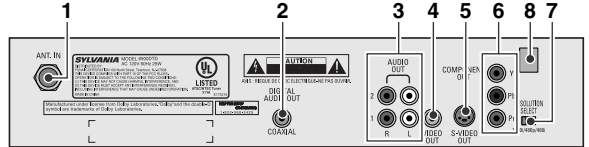

1 Botón POWER:

Para encender y apagar el STB.

2 Indicador POWER:

Se ilumina cuando el STB está encendido.

NOTA:

Cuando se enciende el STB, el indicador POWER primero parpadea y luego se ilumina de manera constante.

Cuando se apaga el STB, el indicador POWER primero parpadea y luego se apaga.

3 Sensor de mando a distancia:

Recibe las señales desde el mando a distancia, lo que permite controlar el STB a distancia.

4 Botones de navegación ▲ / ▼ / ◀ / ▶:

Presione estos botones para mover el ítem o menú seleccionado hacia arriba, hacia abajo, hacia la izquierda o hacia la derecha.

5 Botón SETUP:

Presione este botón para entrar en el menú SETUP o para salir de él.

6 Botón ENTER:

En el menú SETUP, presione este botón para registrar la opción seleccionada.

7 Botones CHANNEL ▲ / ▼:

Presione este botón para cambiar de canal en dirección de ascenso o descenso.

1 Toma ANT. IN.:

Use esta toma para conectar una antena al STB.

2 Toma DIGITAL AUDIO (COAXIAL):

Use esta toma para conectar un decodificador o amplificador al STB mediante un cable coaxial digital.

NOTA:

Para poder reproducir en el modo Dolby® Digital 5.1, deberá usar esta toma y un receptor Dolby® Digital.

3 Tomas AUDIO R/ L: (2 pares)

Use estas tomas para conectar el televisor, un sistema estereofónico o una videograbadora al STB mediante cables de audio estándar.

4 Toma VIDEO: (compuesto)

Use esta toma para conectar el televisor o una videograbadora al STB mediante un cable de vídeo estándar.

5 Toma S-VIDEO:

Use esta toma para conectar el televisor al STB mediante un cable S-vídeo.

NOTA:

Cuando se utiliza un cable S-vídeo, no es necesario usar un cable de vídeo compuesto (amarillo).

6 Tomas COMPONENT VIDEO (Y/ Pb/ Pr):

Use estas tomas para conectar el televisor al STB mediante cables de vídeo de componente.

NOTA:

Esta conexión es necesaria para visualizar emisiones de alta definición. Y (verde), Pb (azul), Pr (rojo)

7 Interruptor selector de resolución (1080i/ 480p/ 480i):

Use este interruptor para seleccionar la resolución de salida de vídeo del STB: 1080i, 480p o 480i.

8 Cable de alimentación de CA:

Conéctelo a una toma de CA.

CONTROL REMOTO

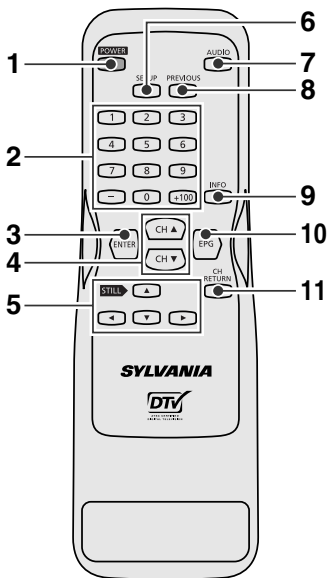

- 1 Botón POWER:**
Para encender y apagar el STB.
- 2 Botones numéricos:**
Use estos botones para introducir números de canal y contraseñas, así como para ajustar la hora.
- 3 Botón ENTER:**
En el menú SETUP, presione este botón para registrar la opción seleccionada.

- 4 Botones CH ▲ / ▼:**
Presione este botón para cambiar de canal en dirección de ascenso o descenso.
- 5 Botones de navegación ▲ / ▼ / ◀ / ▶:**
Presione estos botones para mover el cursor hacia arriba, hacia abajo, hacia la izquierda o hacia la derecha.
Para hacer una pausa en el vídeo y seguir escuchando el programa de audio, presione el botón STILL ▲.
- 6 Botón SETUP:**
Presione este botón para entrar en el menú SETUP o para salir de él.
- 7 Botón AUDIO:**
Use este botón para seleccionar una pista de audio alternativa mientras ve un programa de TV.
- 8 Botón PREVIOUS:**
Use este botón para retroceder a la pantalla anterior del menú SETUP o para salir de este menú.
- 9 Botón INFO:**
Use este botón para visualizar información adicional en el recuadro de canal o para salir.
- 10 Botón EPG:**
Use este botón para visualizar la EPG (Guía de programas electrónicos) o para salir.
- 11 Botón CH RETURN:**
Use este botón para volver al último canal que estaba viendo.

Instalación de las pilas

- 1 Quite la tapa del compartimiento de las pilas, situada en la parte posterior del mando a distancia.**

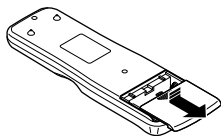

- 2 Instale dos pilas AA, asegurándose de que la polaridad (+ / -) de las mismas sea correcta.**

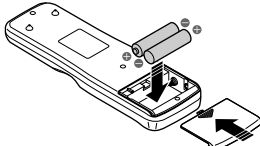

NOTA:

Al cambiar las pilas, asegúrese de reemplazar las dos pilas al mismo tiempo.

- 3 Coloque la tapa del compartimiento de las pilas.**

PRECAUCIÓN:

- No utilice simultáneamente pilas de distinto tipo. (alcalinas y de manganeso)
- No recargue, cortocircuite, caliente, quemé ni desarme las pilas.

Conexiones de antena

Use un cable de antena estándar para conectar la toma mural a la toma ANT IN del STB.

Conexión del STB a la antena

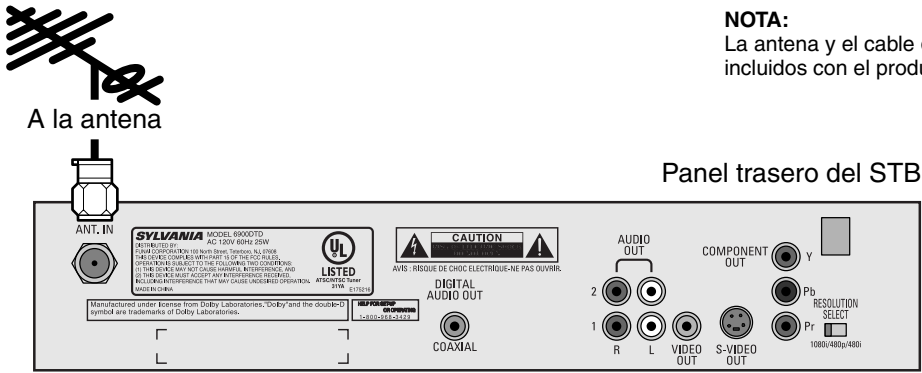

AL CONECTAR EL EQUIPO A UNA CAJA PARA CABLE:

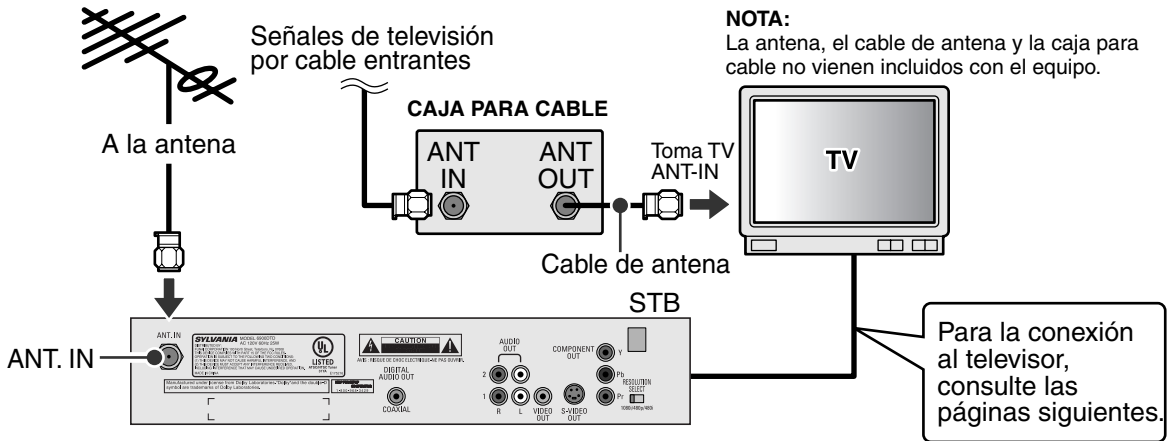

1 Use un cable de antena estándar para conectar la toma mural a la toma ANT IN del STB.

NOTA:

Para la conexión al televisor, consulte las páginas siguientes.

2 Use un cable entrante para realizar la conexión a la toma de entrada de antena de la caja para cable.

3 Use un cable de antena estándar para conectar la toma de salida de antena de la caja para cable a la toma de entrada de antena del televisor.

4 Después de completar la conexión al televisor, conecte el cable de alimentación de CA del televisor a la toma de CA y encienda el televisor.

5 Seleccione el canal de salida en la caja para cable, es decir, el canal 3 o 4.

NOTA:

Para más información, consulte el manual de instrucciones de su televisor.

6 Conecte el cable de alimentación de CA del STB a la toma de CA y luego encienda el STB.

Conexión del STB a un SDTV utilizando la salida VIDEO

NOTA:

El cable de audio y el cable vídeo no vienen incluidos con el producto.

Panel trasero del STB

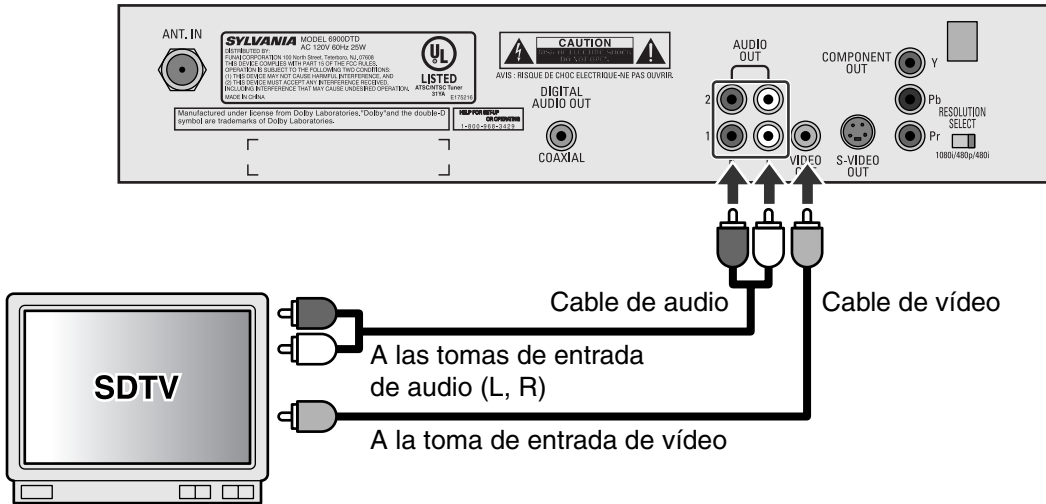

- 1 Use un cable de antena estándar para conectar la toma mural a la toma ANT IN del STB.
- 2 Use un cable de audio estándar para conectar las tomas de salida de audio (L, R) del STB a las tomas de entrada de audio (L, R) del televisor.

NOTA:

Si su televisor es monofónico (MONO) y sólo tiene una toma de audio, conecte un cable de audio estándar (blanco) entre la toma de salida de audio (blanca) del STB y la toma de entrada de audio (blanca) del televisor. En este caso, el cable y la toma rojos no se utilizan.

- 3 Use un cable de vídeo estándar para conectar la toma de salida de vídeo del STB a la toma de entrada de vídeo del televisor.
- 4 Ajuste el interruptor selector de resolución a la posición "480i."
- 5 Después de completar la conexión al televisor, conecte el cable de alimentación de CA del televisor a la toma de CA y encienda el televisor.
- 6 Ponga el televisor en el modo de entrada.

NOTA:

Para más información, consulte el manual de instrucciones de su televisor.

- 7 Conecte el cable de alimentación de CA del STB a la toma de CA y luego encienda el STB.

NOTA:

Si se utiliza un cable de vídeo estándar para realizar la conexión, la resolución de la señal de vídeo de salida siempre será 480i.

Configuración inicial

ASISTENTE PARA LA CONFIGURACIÓN (SETUP WIZARD)

El SETUP WIZARD es un práctico menú que le ayuda hacer los ajustes iniciales del STB.

Cuando se enciende el STB por primera vez después de conectar el cable de alimentación de CA, el SETUP WIZARD aparece automáticamente en la pantalla. En este menú se pueden configurar los siguientes ítems para el ajuste inicial del equipo.

- Idioma para la pantalla
- Búsqueda de canales
- Horario de ahorro de luz diurna (DST)
- Zona horaria
- Año/ fecha/ hora
- Reloj
- Formato de la pantalla y modo de visualización

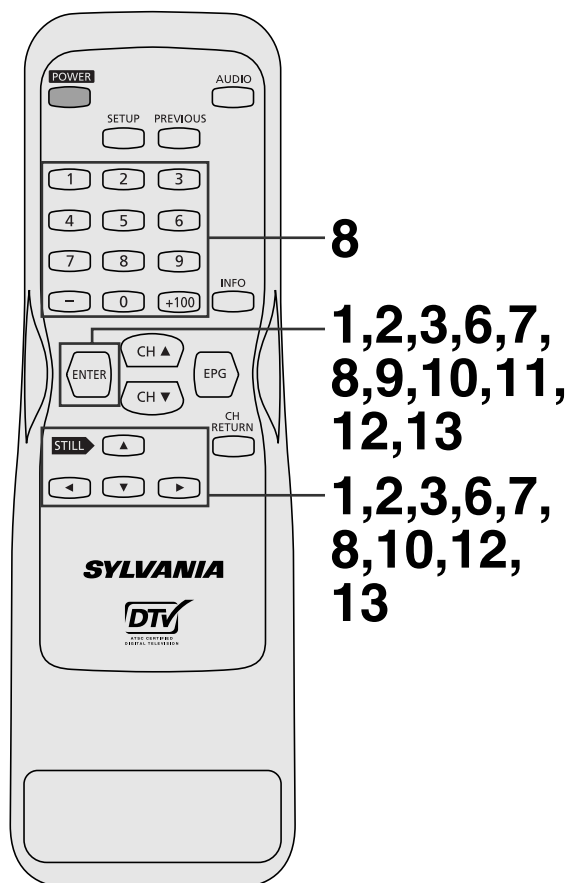

1 Aparecerá el SETUP WIZARD.

2 Seleccione SETUP utilizando los botones de navegación ◀/▶ y, a continuación, presione ENTER.

- Aparecerá la pantalla SETUP WIZARD 1/8.

3 Seleccione el idioma deseado utilizando los botones de navegación ▲/▼ y, a continuación, presione ENTER.

- El idioma seleccionado se activará.
- Aparecerá la pantalla SETUP WIZARD 2/8.

4 El STB comienza a buscar canales.

- Espere hasta que la exploración finalice.
- Cuando la exploración finalice, se visualizará "100%" en el cuadro y luego aparecerá la pantalla siguiente.

Para omitir la exploración:

Presione ENTER.

5 Aparecerá la pantalla SETUP WIZARD 3/8.

6 Seleccione ON u OFF para Horario de ahorro de luz diurna (DST) utilizando los botones de navegación ◀/▶ y, a continuación, presione ENTER.

- Aparecerá la pantalla SETUP WIZARD 4/8.

7 Seleccione la zona horaria deseada utilizando los botones de navegación ▲/▼/◀/▶ y, a continuación, presione ENTER.

- Aparecerá la pantalla SETUP WIZARD 5/8.

NOTA:

Consulte "INFORMATION on Time Zone (INFORMACIÓN sobre las zonas horarias)" en la página 61.

8 Introduzca el año (YEAR), fecha (DATE) y hora (TIME) utilizando los botones de navegación ▲/▼/◀/▶ o los botones numéricos.

- Cada vez que introduzca un número, presione ENTER para mover el cursor.
- Si desea retroceder o avanzar, presione los botones de navegación ◀/▶ para mover el cursor.

NOTA:

Una vez que haya introducido toda la información, el cursor se moverá a SET.

RECOMENDACIÓN:

Para ajustar el año (YEAR), introduzca los 2 últimos dígitos del año. El año quedará registrado. (Por ejemplo, si introduce "03" con los botones numéricos, se visualizará 2003.)

9 Cuando el cursor se encuentre en SET, presione ENTER.

- Los ajustes realizados se activarán.
- Aparecerá la pantalla SETUP WIZARD 6/8 y el STB comenzará a buscar canales con "ajuste automático de reloj" para mantener la hora correcta.

10 Seleccione el canal deseado en el mapa de canales utilizando los botones de navegación ▲/▼.

NOTA:

Los números de los canales que contienen datos de reloj cambiarán a color negro en el mapa de canales.

NOTA:

▲ : Indica que hay más canales hacia arriba o hacia abajo.

▲ : Indica el límite superior o inferior del mapa de canales.

Si no desea usar la función de ajuste automático de reloj:

Seleccione OFF en el mapa de canales y presione ENTER.

RECOMENDACIÓN:

OFF se encuentra en el extremo superior del mapa de canales. Presione repetidamente el botón de navegación o para desplazarse a esta posición.

11 Presione ENTER.

- Aparecerá la pantalla SETUP WIZARD 7/8.

12 Seleccione el formato de pantalla deseado utilizando los botones de navegación ▲/▼ y, a continuación, presione ENTER.

- Aparecerá la pantalla SETUP WIZARD 8/8.

NOTA:

Para más información, consulte la sección "Selecting screen formats (Selección de formatos de pantalla)" en la página 54.

13 Seleccione el modo de visualización deseado utilizando los botones de navegación ▲/▼ y, a continuación, presione ENTER.

- Esto completa el procedimiento del SETUP WIZARD. El STB comenzará a recibir emisiones.

NOTA:

Para más información, consulte la sección "Selecting screen formats (Selección de formatos de pantalla)" en la página 54.

SYLVANIA

LIMITED WARRANTY

FUNAI CORP. will repair this SYLVANIA product, free of charge in the USA in the event of defect in materials or workmanship as follows:

DURATION:

PARTS: FUNAI CORP. will provide parts to replace defective parts without charge for one (1) year from the date of original retail purchase. Two (2) years for Picture Tube. Certain parts are excluded from this warranty.

LABOR: FUNAI CORP. will provide the labor without charge for a period of ninety (90) days from the date of original retail purchase.

LIMITS AND EXCLUSIONS:

This warranty is extended only to the original retail purchaser. A purchase receipt or other proof of original retail purchase will be required together with the product to obtain service under this warranty.

This warranty shall not be extended to any other person or transferee.

This warranty is void and of no effect if any serial numbers on the product are altered, replaced, defaced, missing or if service was attempted by an unauthorized service center. This SYLVANIA Limited warranty does not apply to any product not purchased and used in the United States.

This warranty only covers failures due to defects in material or workmanship which occurs during normal use. It does not cover damage which occurs in shipment, or failures which are caused by repairs, alterations or product not supplied by FUNAI CORP., or damage which results from accident, misuse, abuse, mishandling, misapplication, alteration, faulty installation, improper maintenance, commercial use such as hotel, rental or office use of this product or damage which results from fire, flood, lightning or other acts of God.

THIS WARRANTY DOES NOT COVER PACKING MATERIALS, ANY ACCESSORIES (EXCEPT REMOTE CONTROL), ANY COSMETIC PARTS, COMPLETE ASSEMBLY PARTS, DEMO OR FLOOR MODELS.

FUNAI CORP. AND ITS REPRESENTATIVES OR AGENTS SHALL IN NO EVENT BE LIABLE FOR ANY GENERAL, INDIRECT OR CONSEQUENTIAL DAMAGES ARISING OUT OF OR OCCASIONED BY THE USE OF OR THE INABILITY TO USE THIS PRODUCT. THIS WARRANTY IS MADE IN LIEU OF ALL OTHER WARRANTIES, EXPRESS OR IMPLIED, AND OF ALL OTHER LIABILITIES ON THE PART OF FUNAI, ALL OTHER WARRANTIES INCLUDING THE WARRANTY OF MERCHANTABILITY, AND FITNESS FOR A PARTICULAR PURPOSE, ARE HEREBY DISCLAIMED BY FUNAI AND ITS REPRESENTATIVES IN THE UNITED STATES. ALL WARRANTY INSPECTIONS AND REPAIRS MUST BE PERFORMED BY A FUNAI AUTHORIZED SERVICE CENTER. THIS WARRANTY IS VALID WHEN THE UNIT IS CARRIED-IN TO FUNAI AUTHORIZED SERVICE FACILITY.

IMPORTANT:

THIS LIMITED WARRANTY GIVES YOU SPECIFIC LEGAL RIGHTS, YOU MAY HAVE OTHER RIGHTS THAT VARY FROM STATE TO STATE. IF, AT ANY TIME DURING THE WARRANTY PERIOD, YOU ARE UNABLE TO OBTAIN SATISFACTION WITH THE REPAIR OF THIS PRODUCT, PLEASE CONTACT FUNAI CORP.

ATTENTION:

FUNAI CORP. RESERVES THE RIGHT TO MODIFY ANY DESIGN OF THIS PRODUCT WITHOUT PRIOR NOTICE.

To locate your nearest SYLVANIA Authorized Service Center or for general service procedure, please call 1-800-968-3429 or write to the following:

**FUNAI CORPORATION, INC.
SERVICE CENTER**

19900 Van Ness Avenue, Torrance, CA 90501

Tel :1-800-968-3429

<http://www.funai-corp.com>

Head Office: 100 North Street, Teterboro, NJ 07608

PLEASE DO NOT SHIP YOUR UNIT TO THE TETERBORO ADDRESS.